

Unit FE-3 Foundation Electricity: Basic AC Theory

What this unit is about

Electrical energy is on the whole generated in AC form. The reasons why this is so are explained and the response of resistors, inductors and capacitors to the application of AC voltage are analysed. It is shown that to calculate the current in AC circuits containing R plus L and/or C components it is necessary to use phasor rather than scalar quantities. It is also shown that calculations are greatly eased if complex algebra is employed. Typical mixed circuits are then analysed using complex notation. Finally, it is pointed out that if power electronic circuits are employed, their non-linear effect results in non-sinusoidal quantities, which can be determined through Fourier analysis. The implications of the presence of harmonics in power networks are then discussed.

Why is this knowledge necessary?

Renewable energy sources are used mainly to generate AC electrical power, which is injected into power networks consisting of large number of transmission lines, other conventional generators and consumers. Such power networks, especially in developed countries, are of considerable complexity. To determine the way these injected powers flow from generators to consumers requires complex calculations based on network analysis. This unit introduces the basic AC circuit theory that enables students to carry out network analysis in simple power circuits consisting of R, L and C components. This knowledge is an essential prerequisite in the understanding of power flows in networks. Frequently, renewable energy generators are interfaced to power networks through power electronic converters. The non-linear nature of such converters is examined and the reasons why converters generate harmonics are explained. The undesirable effects of harmonics injected into power networks are discussed.

At the beginning of each section the course module(s) that requires the material in this particular section as background knowledge are indicated in bold italics. All sections of this unit are required as background material for Unit FE-4. Some sections contain simple exercises.

N.B. The text uses 60 rather than 50 Hz as the mains frequency. This is of no consequence in the understanding of the material and in its application to 50 Hz systems.

Contents

	Page No.
1. Alternating Current	
1.1 Why Alternating Current?	3
1.2 AC Waveforms	6
1.3 Measurements of AC Magnitude	8
1.4 Simple AC Circuit Calculations	12
1.5 AC Phase	13
2. Phasors and Complex Numbers	
2.1 Scalars and Phasors	15
2.2 Phasors and Waveforms	16
2.3 Simple Phasor Addition	17
2.4 General Phasor Addition	19
2.5 Polar and Rectangular Notation	20
2.6 Complex Number Arithmetic	23
2.7 Some Examples with AC Circuits	24
3. The Concept of Impedance	
3.1 AC Resistor Circuits	27
3.2 AC Inductor Circuits	27
3.3 Series Resistor-Inductor Circuits	31
3.4 Parallel Resistor-Inductor Circuits	34
3.5 More on Inductors	35
3.6 AC Capacitor Circuits	36
3.7 Series Resistor-Capacitor Circuits	39
3.8 Parallel Resistor-Capacitor Circuits	40
3.9 More on Capacitors	41
4. Resonance and Other Topics	
4.1 Resonance	43
4.2 Non-sinusoidal Waveforms	44
4.3 Non-linear Circuit Components	45
4.4 More on Spectrum Analysis	47
4.5 Circuit Effects	48

1. Alternating Current

1.1 Why Alternating Current?

[This material relates predominantly to module ELP032]

As useful and as easy to understand as DC is, it is not the only "kind" of electricity in use. Certain sources of electricity (most notably, rotary electro-mechanical generators) naturally produce voltages alternating in polarity, reversing positive and negative over time. Either as a voltage switching polarity or as a current switching direction back and forth, this "kind" of electricity is known as Alternating Current (AC):

Whereas the familiar battery symbol is used as a generic symbol for any DC voltage source, a circle with a wavy line inside is the generic symbol for any AC voltage source.

One might wonder why anyone would bother with such a thing as AC. It is true that in some cases AC holds no practical advantage over DC. In applications where electricity is used to dissipate energy in the form of heat, the polarity or direction of current is irrelevant. However, with AC it is possible to build electric generators and motors that are far more efficient than the DC equivalents and it is possible to use a variety of voltages in the transmission and distribution of electrical energy (a very important issue to be discussed in the module ELP032). So AC has been adopted across the world in high power applications (although DC is used for special cases of bulk power transfer through high voltage cables). To explain the details of why this is so, background knowledge about AC is necessary.

Alternator operation

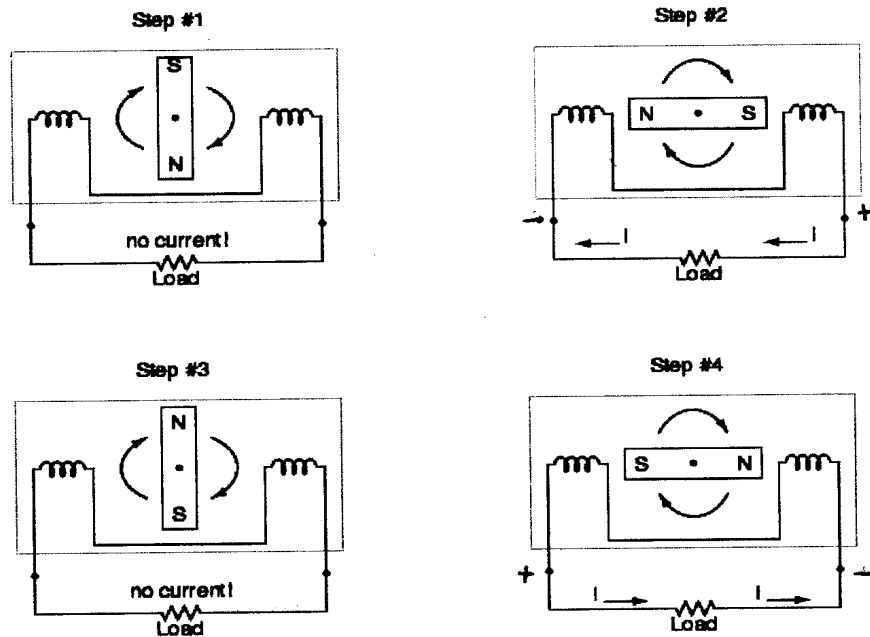

If a machine is constructed to rotate a magnetic field around a set of stationary wire coils with the turning of a shaft, AC voltage will be produced across the wire coils as that shaft

is rotated, in accordance with Faraday's Law of electromagnetic induction. This is the basic operating principle of an AC generator, also known as an *alternator*:

Notice how the polarity of the voltage across the wire coils reverses as the opposite poles of the rotating magnet pass by. Connected to a load, this reversing voltage polarity will create a reversing current direction in the circuit. The faster the alternator's shaft is turned, the faster the magnet will spin, resulting in an alternating voltage and current of higher frequency.

While DC generators work on the same general principle of electromagnetic induction, their construction is not as simple as their AC counterparts. With a DC generator, the coils are mounted in the shaft where the magnet is on the AC alternator, and electrical connections are made to this spinning coil via stationary carbon "brushes" contacting copper strips on the rotating shaft. All this is necessary to switch the coil's changing output polarity to the external circuit so the external circuit sees a constant polarity: The problems involved with making and breaking electrical contact with a moving coil should be obvious (sparking and heat), especially if the shaft of the generator is revolving at high speed.

The benefits of AC over DC with regard to generator design are also reflected in electric motors. So we know that AC generators and AC motors tend to be simpler than DC generators and DC motors. This relative simplicity translates into greater reliability and lower cost of manufacture.

But what else is AC good for? Surely there must be more to it than design details of generators and motors! Indeed there is. There is an effect of electromagnetism known as *mutual induction*, which was referred to in Unit FE-1. If we have two magnetically coupled coils and we energise one coil with AC, we will create an AC voltage in the other coil. When used as such, this device is known as a *transformer*:

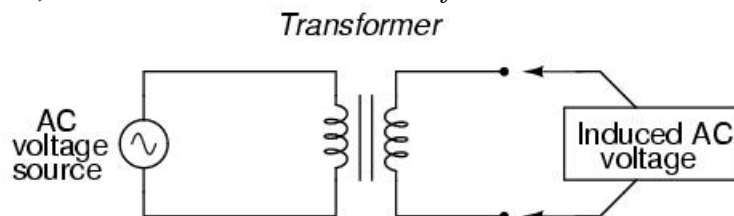

The fundamental significance of a transformer is its ability to step voltage up or down from the powered coil to the unpowered coil. The AC voltage induced in the unpowered ("secondary") coil is equal to the AC voltage across the powered ("primary") coil multiplied by the ratio of secondary coil turns to primary coil turns. If the secondary coil is powering a load, the current through the secondary coil is just the opposite: primary coil current multiplied by the ratio of primary to secondary turns. This relationship has a very close mechanical analogy, using torque and speed to represent voltage and current, respectively:

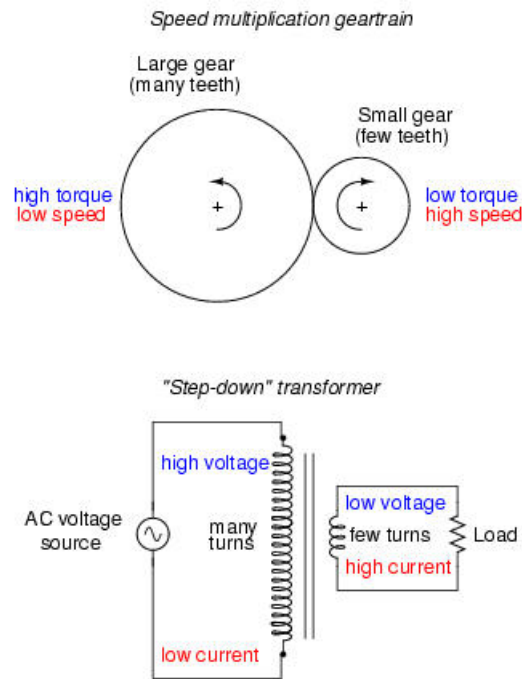

If the winding ratio is reversed so that the primary coil has fewer turns than the secondary coil, the transformer "steps up" the voltage from the source level to a higher level at the load:

The transformer's ability to step AC voltage up or down with ease gives AC an advantage unmatched by DC in the realm of power distribution. When transmitting electrical power over long distances, it is far more efficient to do so with stepped-up voltages and stepped-down currents (smaller-diameter wire with less resistive power losses), then step the voltage back down and the current back up for industry, business, or consumer use.

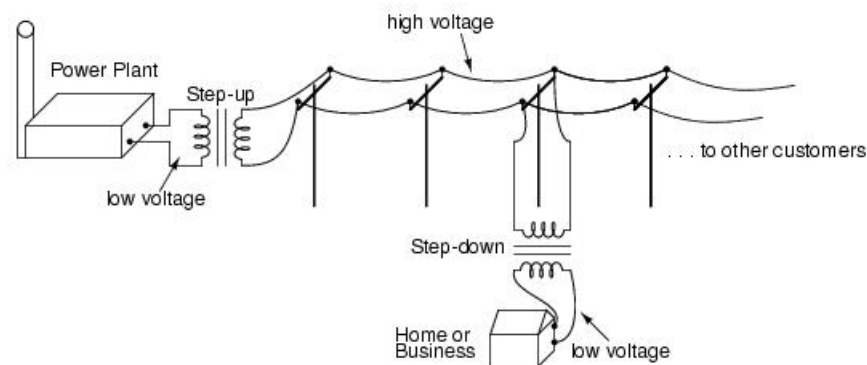

Transformer technology has made long-range electric power distribution practical. Without the ability to efficiently step voltage up and down, it would be cost-prohibitive to construct power systems for anything but close-range (within a few kilometres at most) use.

Section Review:

- AC stands for "Alternating Current," meaning voltage or current that changes polarity or direction, respectively, over time.
- AC electromechanical generators and motors are of simpler construction than DC equivalents.
- A *transformer* is a pair of mutually-inductive coils used to convey AC power from one coil to the other. Often, the number of turns in each coil is set to create a voltage increase or decrease from the powered (primary) coil to the unpowered (secondary) coil.

1.2 AC Waveforms

Alternators are designed to produce an AC voltage that is very close to a pure *sine wave*.

If we were to follow the changing voltage produced by a coil in an alternator from any point on the sine wave graph to that point when the wave shape begins to repeat itself, we would have marked exactly one *cycle* of that wave. This is most easily shown by spanning the distance between identical peaks, but can be measured between any corresponding points on the graph. The degree marks on the horizontal axis of the graph represent the domain of the trigonometric sine function, and also the angular position of our simple two-pole alternator shaft as it rotates:

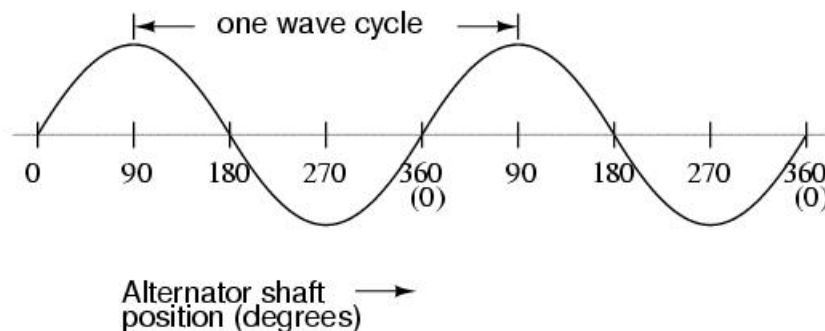

Since the horizontal axis of this graph can mark the passage of time as well as shaft position in degrees, the dimension marked for one cycle can be measured in a unit of time, most often fractions of a second. When expressed as a measurement, this is often called the *period* of a wave and it is usually designated by "T".

A more popular measure for describing the alternating rate of an AC voltage or current wave than *period* is the *frequency* (i.e. the "cycles per second") in Hertz (abbreviated Hz) usually designated by "f".

Period and frequency are mathematical reciprocals of one another. That is to say, if a wave has a period of 10 seconds, its frequency will be 0.1 Hz, or 1/10 of a cycle per second:

$$\text{Frequency in Hertz} = \frac{1}{\text{Period in seconds}}$$

While electromechanical alternators are designed to produce sine waves, this is not the only kind of alternating wave in existence. Other "waveforms" of AC are commonly

produced within electronic circuitry. Here are but a few sample waveforms and their common designations:

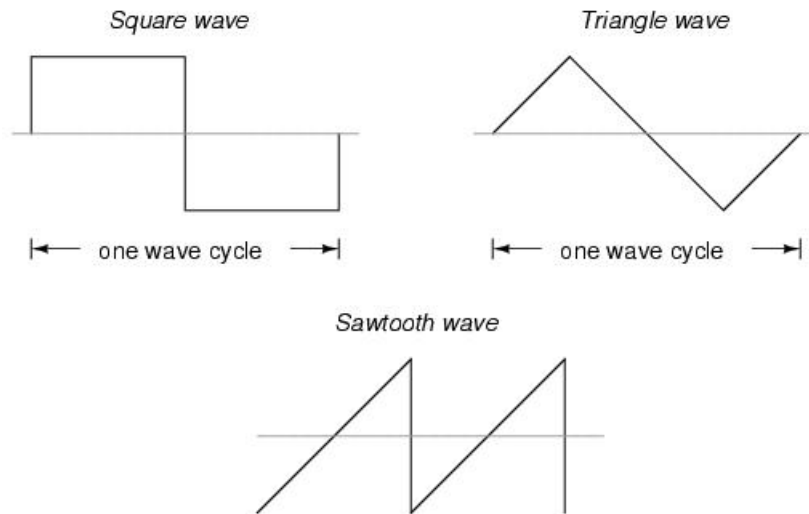

Even in circuits that are supposed to manifest "pure" sine, square, triangle, or sawtooth voltage/current waveforms, the real-life result is often a distorted version of the intended waveshape. Some waveforms are so complex that they defy classification as a particular "type" (including waveforms associated with many kinds of musical instruments). Generally speaking, any waveshape bearing close resemblance to a perfect sine wave is termed *sinusoidal*, anything different being labelled as *non-sinusoidal*. Power electronic converters used extensively to interface renewable energy generators to power networks generate non-sinusoidal waveforms. The implications of this are discussed at the end of this unit.

Section Review:

- AC produced by an electromechanical alternator follows the graphical shape of a sine wave.
- One *cycle* of a wave is one complete evolution of its shape until the point that it is ready to repeat itself.
- The *period* of a wave is the amount of time it takes to complete one cycle.
- *Frequency* is the number of cycles that a wave completes in a given amount of time and it is measured in Hertz (Hz), 1 Hz being equal to one complete wave cycle per second.
- $f=1/T$

1.3 Measurements of AC Magnitude

With AC we encounter a measurement problem if we try to express how large or small the quantity is. With DC, where quantities of voltage and current are stable, we have little trouble expressing how much voltage or current we have in any part of a circuit. But how do you grant a single measurement of magnitude to something that is constantly changing?

One way to express the magnitude of an AC quantity is to measure its peak height on a waveform graph. This is known as the *peak* or *crest* value of an AC waveform:

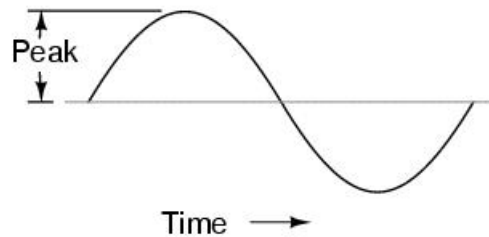

Another way is to measure the total height between opposite peaks. This is known as the *peak-to-peak* (P-P) value of an AC waveform:

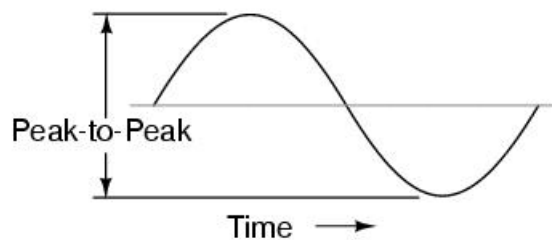

Unfortunately, either one of these expressions of waveform magnitude can be misleading when comparing two different types of waves. For example, a square wave peaking at 10 volts is obviously a greater amount of voltage for a greater amount of time than a triangle wave peaking at 10 volts. The effects of these two AC voltages powering a load would be quite different:

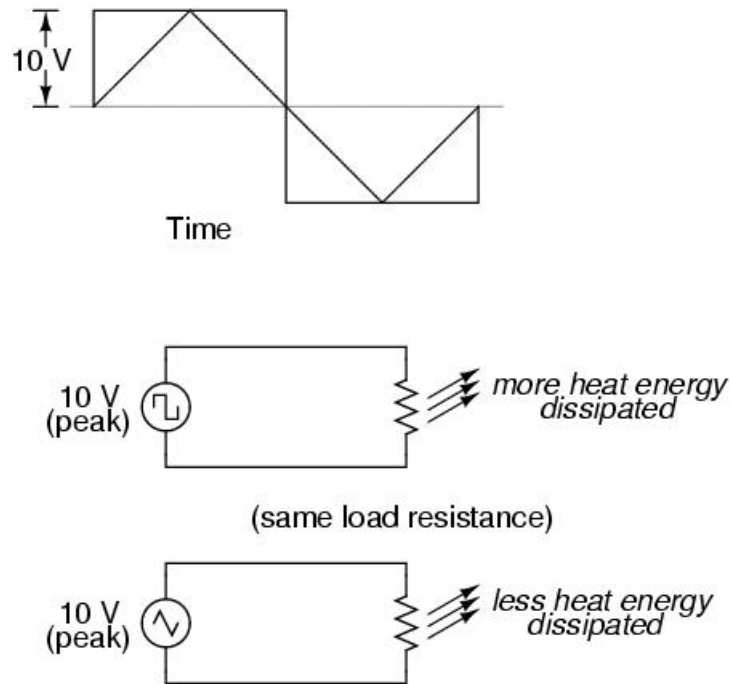

One way of expressing the magnitude of different waveshapes in a more equivalent fashion is to mathematically average the values of all the positive or negative points on a waveform's graph to a single, aggregate number. The best way to express the magnitudes of AC waveforms equivalently, however, is to rate them in terms of their *ability to perform useful work*, and the mathematical average of an AC waveform doesn't represent that.

Anyone familiar with modern woodworking equipment knows what a bandsaw and a jigsaw are. Both types of saws cut with a thin, toothed, motor-powered metal blade to cut wood. But while the bandsaw uses a continuous motion of the blade to cut, the jigsaw uses a back-and-forth motion. The comparison of alternating current (AC) to direct current (DC) can be likened to the comparison of these two saw types:

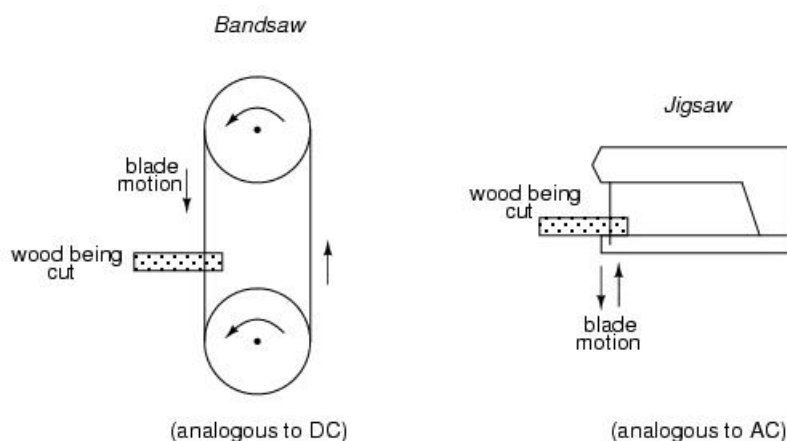

The problem of trying to describe the changing quantities of AC voltage or current in a single measurement is also present in this saw analogy: how might we express the speed of a jigsaw blade?

A bandsaw blade moves with a constant speed, similar to the way DC voltage pushes or DC current moves with a constant magnitude. A jigsaw blade, on the other hand, moves

back and forth, its blade speed constantly changing. What is more, the back-and-forth motion of any two jigsaws may not be of the same type, depending on the mechanical design of the saws. One jigsaw might move its blade with a sine-wave motion, while another with a triangle-wave motion.

To rate a jigsaw based on its *peak* blade speed would be quite misleading when comparing one saw to another (or a jigsaw with a bandsaw!). Despite the fact that these different saws move their blades in different manners, they are equal in one respect: they all cut wood, and a measurement of this equal function can serve as a common basis for which to rate blade speed.

Picture a jigsaw and bandsaw side-by-side, equipped with identical blades (same tooth pitch, angle, etc.), equally capable of cutting the same thickness of the same type of wood at the same rate. We might say that the two saws were equivalent or equal in their cutting capacity.

This is the general idea used to assign a "DC equivalent" measurement to any AC voltage or current: whatever magnitude of DC voltage or current would produce the same amount of heat energy dissipation through an equal resistance:

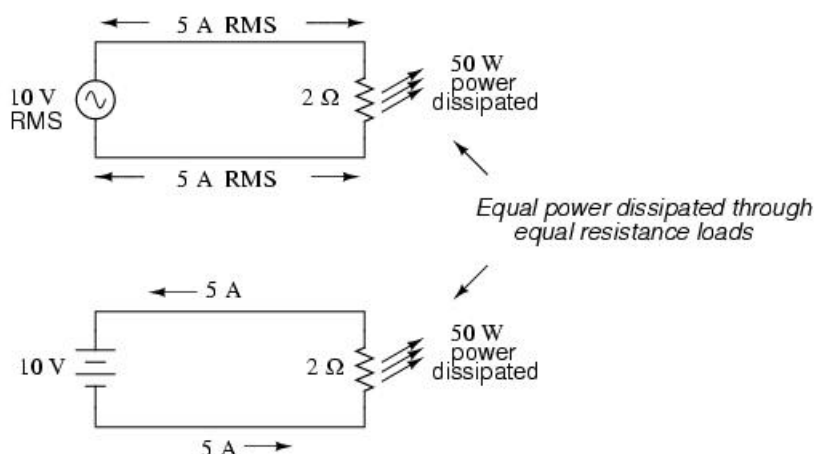

In the two circuits above, we have the same amount of load resistance (2 ohm) dissipating the same amount of power in the form of heat (50 watts), one powered by AC and the other by DC. Because the AC voltage source pictured above is equivalent (in terms of power delivered to a load) to a 10 volt DC battery, we would call this a "10 volt" AC source. More specifically, we would denote its voltage value as being 10 volts *RMS*.

The qualifier "RMS" stands for *Root Mean Square*, which is the mathematical method of deriving the DC equivalent value from points on a graph. Essentially, this method consists of squaring all the positive and negative points on a waveform graph, (remember that the power dissipated in a resistor is proportional to the square of the voltage or current) averaging those squared values, then taking the square root of that average to obtain the final answer. RMS magnitude measurement is the best way to relate AC quantities to DC quantities, or other AC quantities of differing waveform shapes, when dealing with measurements of electric power.

For other considerations, peak or peak-to-peak measurements may be the best to employ. For example, when rating insulators for service in high-voltage AC applications, peak voltage measurements are the most appropriate, because the principal concern here is insulator "flashover" caused by brief spikes of voltage, irrespective of time.

For "pure" waveforms, simple conversion coefficients can be calculated which equate Peak, Peak-to-Peak, Average, and RMS measurements.

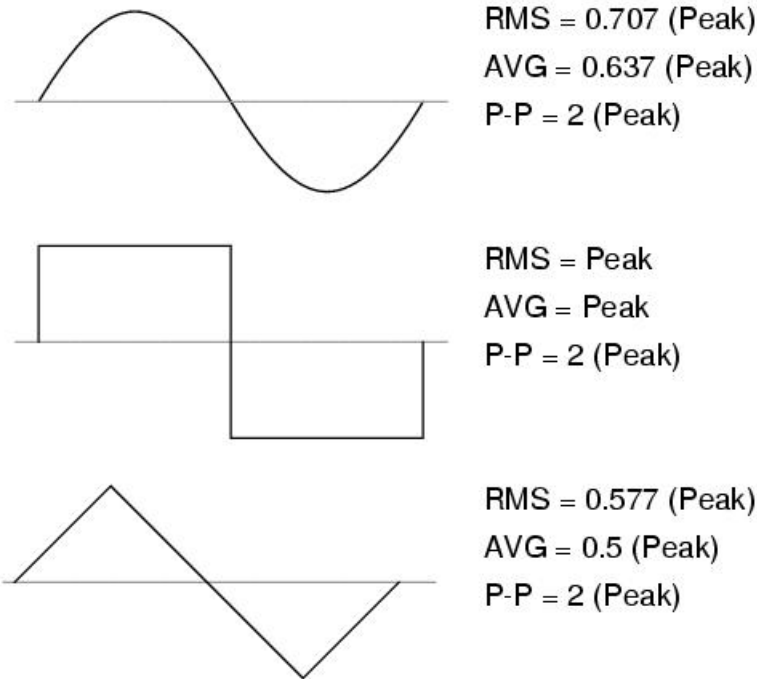

Bear in mind that the conversion constants shown above for RMS and average measurements hold true only for *pure* waveshapes. The RMS and average values of distorted waveshapes are not related by the same multiplier values:



Section Review:

- The *amplitude* of an AC waveform is its peak as depicted on a graph over time.
- *Peak-to-peak* measurement is the total height of an AC waveform as measured from maximum positive to maximum negative peaks on a graph.
- *The Average* measurement is the mathematical "mean" of all positive or all negative points on a waveform graph.
- "RMS" stands for *Root Mean Square*, and is a way of expressing an AC quantity of voltage or current in terms functionally equivalent to DC.

1.4 Simple AC circuit Calculations

Over the course of the next few sections, you will learn that AC circuit measurements and calculations can get very complicated due to the complex nature of alternating current in circuits with inductance and capacitance. However, with simple circuits involving nothing more than an AC power source and resistance, the same laws and rules of DC apply simply and directly.

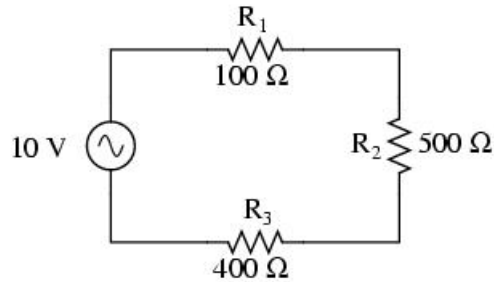

$$R_{\text{total}} = R_1 + R_2 + R_3$$

$$R_{\text{total}} = 1 \text{ k}\Omega$$

$$I_{\text{total}} = \frac{E_{\text{total}}}{R_{\text{total}}}$$

$$I_{\text{total}} = \frac{10 \text{ V}}{1 \text{ k}\Omega}$$

$$I_{\text{total}} = 10 \text{ mA}$$

$$E_{R1} = I_{\text{total}} R_1$$

$$E_{R2} = I_{\text{total}} R_2$$

$$E_{R3} = I_{\text{total}} R_3$$

$$E_{R1} = 1 \text{ V}$$

$$E_{R2} = 5 \text{ V}$$

$$E_{R3} = 4 \text{ V}$$

Series resistances still add, parallel resistances still diminish, and the Laws of Kirchhoff and Ohm still hold true. Actually, as we will discover later on, these rules and laws *always* hold true, it's just that we have to express the quantities of voltage, current, and opposition to current in more advanced mathematical forms. With purely resistive circuits, however, these complexities of AC are of no practical consequence, and so we can treat the numbers as though we were dealing with simple DC quantities.

If the source voltage is given in AC RMS volts then all calculated currents and voltages are in AC RMS units as well. This holds true for *any* calculation based on Ohm's Laws, Kirchhoff's Laws, etc. Unless otherwise stated, all values of voltage and current in AC circuits are generally given and assumed to be RMS rather than peak, average, or peak-to-peak.

Section Review:

- All the old rules and laws of DC (Kirchhoff's Voltage and Current Laws, Ohm's Law) still hold true for AC. However, with more complex circuits, we need to represent the AC quantities in more complex form.

1.5 AC Phase

Things start to get complicated when we need to relate two or more AC voltages or currents of the same frequency that are out of step with each other. By "out of step," we mean that the two waveforms are not synchronised: that their peaks and zero points do not match up at the same points in time. The following graph illustrates an example of this:

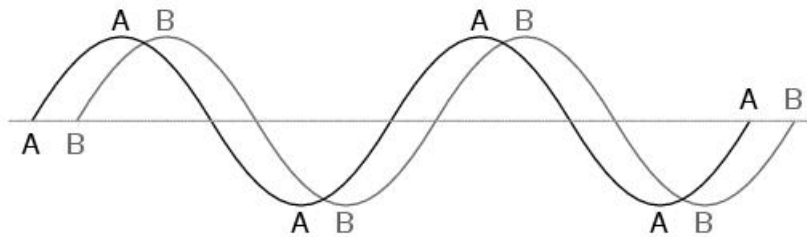

The two waves shown above (A and B) are of the same amplitude and frequency, but they are out of step with each other. In technical terms, this is called a *phase shift*. The shift between these two waveforms is about 45 degrees, the "A" wave being ahead of the "B" wave. A sampling of different phase shifts is given in the following graphs to better illustrate this concept:

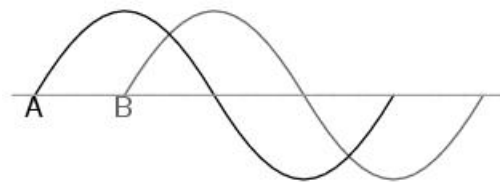

Phase shift = 90 degrees
A is ahead of B
(A "leads" B)

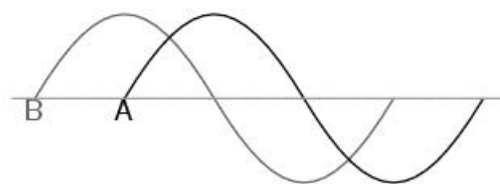

Phase shift = 90 degrees
B is ahead of A
(B "leads" A)

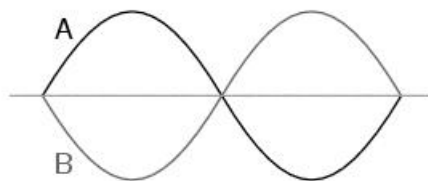

Phase shift = 180 degrees
A and B waveforms are mirror-images of each other

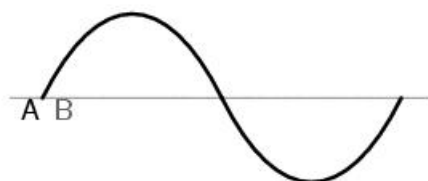

Phase shift = 0 degrees
A and B waveforms are in perfect step with each other

Because the waveforms in the above examples are at the same frequency, they will be out of step by the same angular amount at every point in time. For this reason, we can express phase shift for two or more waveforms of the same frequency as a constant quantity for the entire wave, and not just an expression of shift between any two particular points along the waves. That is, it is safe to say something like, "voltage 'A' is 45 degrees out of phase with voltage 'B'." Whichever waveform is ahead in its evolution is said to be *leading* and the one behind is said to be *lagging*.

Phase shift, like voltage, is always a measurement relative between two things. There's really no such thing as a waveform with an *absolute* phase measurement because there's no such thing as a universal reference for phase. Typically in the analysis of AC circuits, the voltage waveform of the power supply is used as a reference for phase, that voltage stated as "xxx volts at 0 degrees." Any other AC voltage or current in that circuit will have its phase shift expressed in terms relative to that source voltage.

This is what makes AC circuit calculations more complicated than DC. When applying Ohm's Law and Kirchhoff's Laws, quantities of AC voltage and current must reflect phase shift as well as amplitude. Mathematical operations of addition, subtraction, multiplication, and division must operate on these quantities of phase shift as well as amplitude. Fortunately, there is a mathematical system of quantities called *complex numbers* ideally suited for this task of representing amplitude and phase.

Section Review:

- *Phase shift* is where two or more waveforms are out of step with each other.
- The amount of phase shift between two waves can be expressed in terms of degrees.
- A *leading* waveform is defined as one waveform that is ahead of another in its evolution. A *lagging* waveform is one that is behind another.



Example:

- Calculations for AC circuit analysis must take into consideration both amplitude and phase shift of voltage and current waveforms. This requires the use of *complex numbers*.

2. Phasors and Complex Numbers

2.1 Scalars and Phasors

The kind of information that expresses a single dimension, such as linear distance, is called a *scalar* quantity in mathematics. The voltage produced by a battery, for example, is a scalar quantity. So is the resistance of a piece of wire (ohms), or the current through it (amps).

However, when we begin to analyse alternating current circuits, we find that quantities of voltage, current, and even resistance (called *impedance* in AC) are not the familiar one-dimensional quantities we are used to measuring in DC circuits. Rather, these quantities, because they are dynamic (alternating in direction and amplitude), possess other dimensions that must be taken into account. Frequency and phase shift are two of these dimensions that come into play. Even with relatively simple AC circuits, where we're only dealing with a single frequency, we still have the dimension of phase shift to contend with in addition to the amplitude.

In order to successfully analyse AC circuits, we need to work with mathematical objects and techniques capable of representing these multi-dimensional quantities. A complex number is a single mathematical quantity able to express these two dimensions of amplitude and phase shift at once.

Complex numbers are easier to grasp when they're represented graphically. If I draw a line with a certain length (magnitude) and angle (direction), I have a graphic representation of a complex number which is commonly known in physics as a *phasor*:

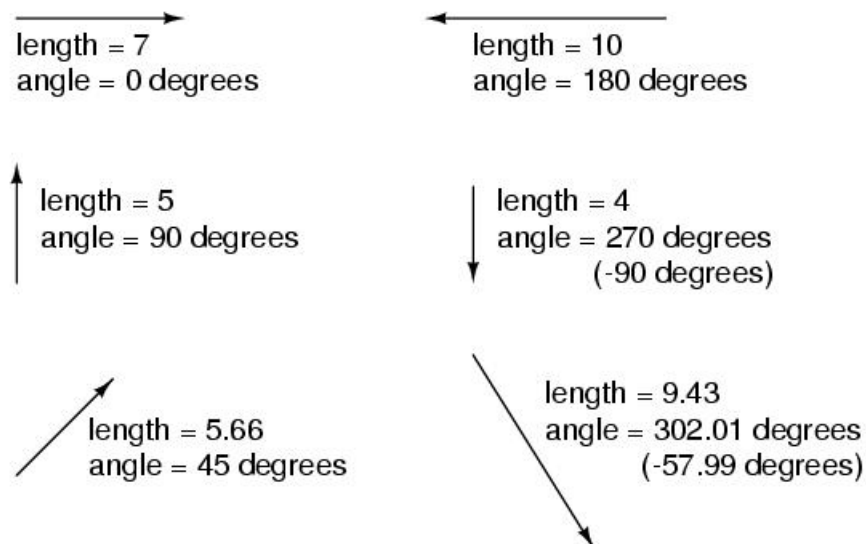

Like distances and directions on a map, there must be some common frame of reference for angle figures to have any meaning. In this case, directly right is considered to be 0° , and angles are counted in a positive direction going counter-clockwise:

One-dimensional, scalar numbers are perfectly adequate for counting beads, representing weight, or measuring DC battery voltage, but they fall short of being able to represent

something more complex like the amplitude *and* phase of an AC waveform. To represent these kinds of quantities, we need multidimensional representations. In other words, we need a number line that can point in different directions, and that's exactly what a phasor is.

Section Review:

- A *scalar* number is the type of mathematical object that people are used to using in everyday life: a one-dimensional quantity like temperature, length, weight, etc.
- A *phasor* is a graphical representation of a complex number. It looks like an arrow, with a starting point, a tip, a definite length, and a definite direction.
- A *complex number* is a mathematical quantity representing two dimensions of magnitude and direction.

2.2 Phasors and Waveforms

So, how exactly can we represent AC quantities of voltage or current in the form of a phasor? The length of the phasor represents the RMS magnitude of the waveform. The greater the magnitude of the waveform, the greater the length of its corresponding phasor. The angle of the phasor, however, represents the phase shift in degrees between the waveform in question and another waveform acting as a "reference" in time. Usually, when the phase of a waveform in a circuit is expressed, it is referenced to the power supply voltage waveform (arbitrarily stated to be "at" 0°). If there is more than one AC voltage source, then one of those sources is arbitrarily chosen to be the phase reference for all other measurements in the circuit. Remember that phase is always a *relative* measurement between two waveforms rather than an absolute property.

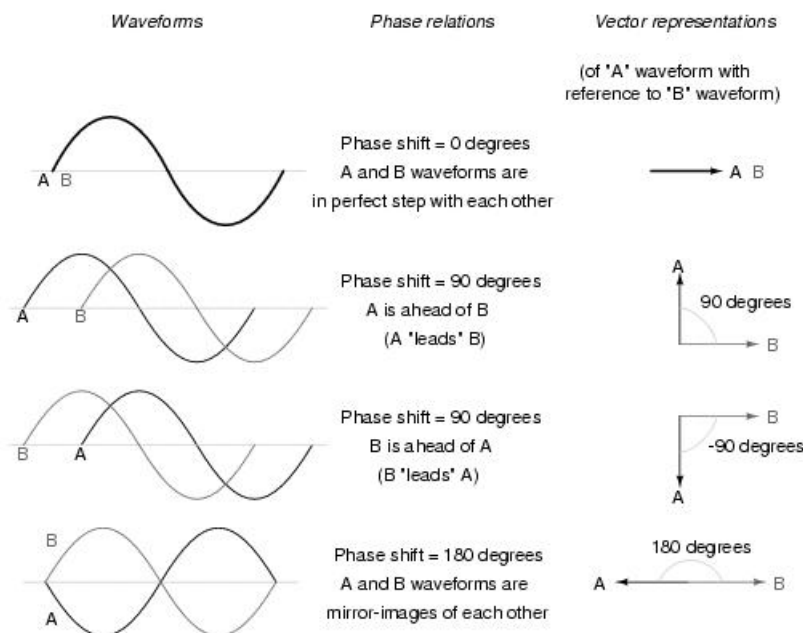

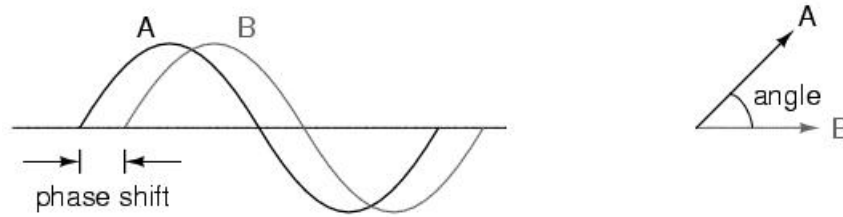

The greater the phase shift in degrees between two waveforms, the greater the angle difference between the corresponding phasors.

This concept of a reference point is not unlike that of the "ground" point in a circuit for the benefit of voltage reference. With a clearly defined point in the circuit declared to be "ground," it becomes possible to talk about voltage "on" or "at" single points in a circuit, being understood that those voltages (always relative between *two* points) are referenced to "ground." Correspondingly, with a clearly defined point of reference for phase it becomes possible to speak of voltages and currents in an AC circuit having definite phase angles. Example: "the current through resistor R₅ is 24.3 amps at -64 degrees," which means the current waveform lags 64° behind the main source voltage waveform.

Section Review:

- When used to describe an AC quantity, the length of a phasor represents the RMS magnitude of the wave while the angle of a phasor represents the phase angle of the wave relative to some other (reference) waveform.

2.3 Simple Phasor Addition

Remember that phasors are mathematical objects just like numbers on a number line: they can be added, subtracted, multiplied, and divided. Addition is perhaps the easiest phasor operation to visualise, so we'll begin with that. If phasors with common angles are added, their magnitudes (lengths) add up just like regular scalar quantities:



Similarly, if AC voltage sources with the same phase angle are connected together in series, their voltages add just as you might expect with DC batteries:

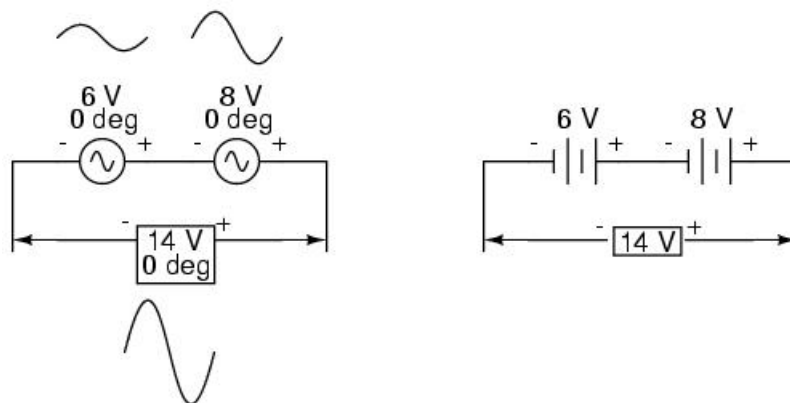

Determining whether or not these voltage sources are opposing each other requires an examination of their polarity markings *and* their phase angles. Notice how the polarity markings in the above diagram seem to indicate additive voltages (from left to right, we see - and + on the 6 volt source, - and + on the 8 volt source). Even though these polarity markings would normally indicate an *additive* effect in a DC circuit (the two voltages working together to produce a greater total voltage), in the AC circuit below they're actually pushing in opposite directions because one of those voltages has a phase angle of 0° and the other a phase angle of 180° . The result, of course, is a total voltage of 2 volts.

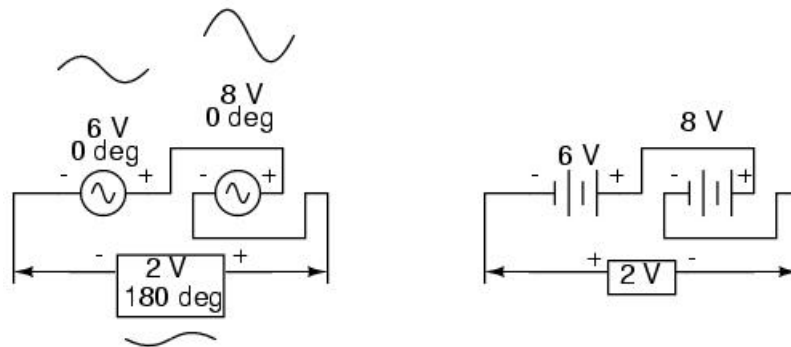

Since both sources are listed as having equal phase angles (0°), they truly are opposed to one another, and the overall effect is the same as the former scenario with "additive" polarities and differing phase angles: a total voltage of only 2 volts.

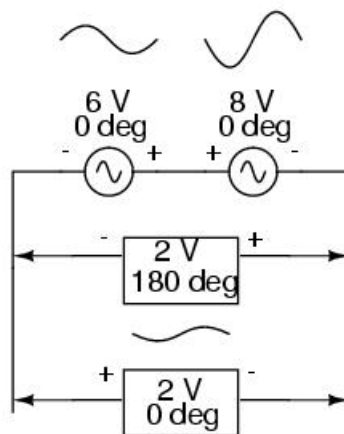

Just as there are two ways to express the phase of the sources, there are two ways to express their resultant sum.

The resultant voltage can be expressed in two different ways: 2 volts at 180° with the (-) symbol on the left and the (+) symbol on the right, or 2 volts at 0° with the (+) symbol on the left and the (-) symbol on the right. A reversal of wires from an AC voltage source is the same as phase-shifting that source by 180° .

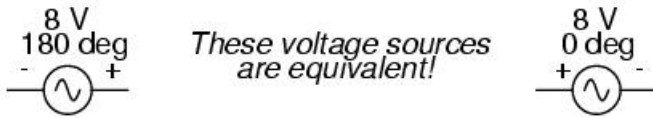

2.4 General Phasor Addition

If phasors with uncommon angles are added, their magnitudes (lengths) add up quite differently than that of scalar magnitudes:

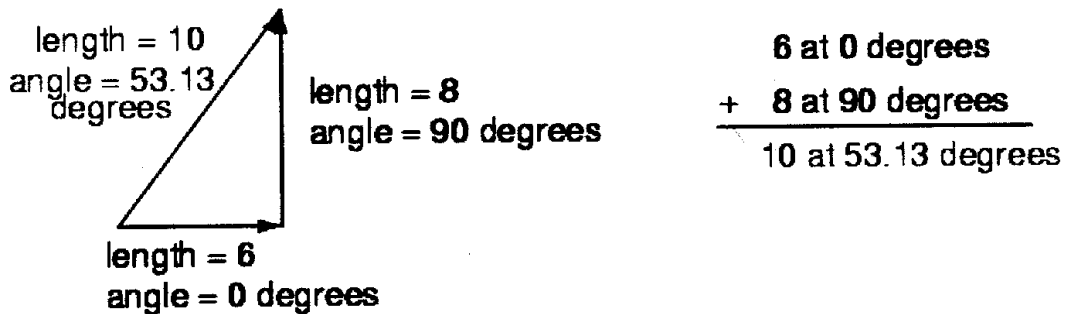

If two AC voltages, 90° out of phase, are added together by being connected in series, their voltage magnitudes do not directly add or subtract as with scalar voltages in DC. Instead, these voltage quantities are complex quantities, and just like the above phasors, which add up in a trigonometric fashion, a 6 volt source at 0° added to an 8 volt source at 90° results in 10 volts at a phase angle of 53.13° :

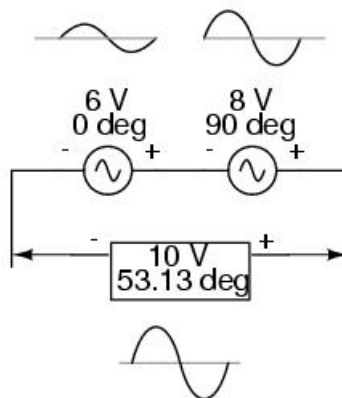

Compared to DC circuit analysis, this is very strange indeed. Note that it's possible to obtain voltmeter indications of 6 and 8 volts, respectively, across the two AC voltage sources, yet only read 10 volts for a total voltage!

There is no suitable DC analogy for what we're seeing here with two AC voltages out of phase. DC voltages can only directly aid or directly oppose, with nothing in between. With AC, two voltages can be aiding or opposing one another *to any degree* between fully-aiding and fully-opposing, inclusive. Without the use of phasor (complex number) notation to describe AC quantities, it would be *very* difficult to perform mathematical calculations for AC circuit analysis.

Section Review:

- DC voltages can only either directly aid or directly oppose each other when connected in series. AC voltages may aid or oppose *to any degree* depending on the phase shift between them.

2.5 Polar and Rectangular Notation

In order to work with these complex numbers without drawing phasors, we first need some kind of standard mathematical notation. There are two basic forms of complex number notation: *polar* and *rectangular*.

Polar form is where a complex number is denoted by the *length* (otherwise known as the *magnitude*, *absolute value*, or *modulus*) and the *angle* of its phasor. Here are two examples of phasors and their polar notations:

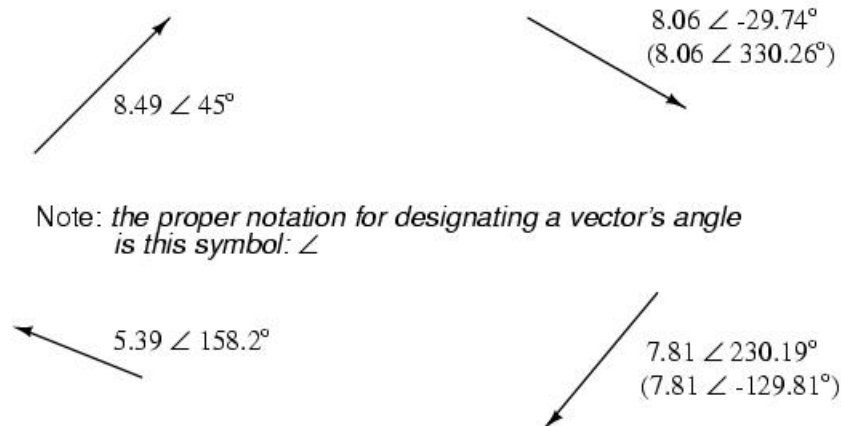

Standard orientation for phasor angles in AC circuit calculations defines 0° as being to the right (horizontal), making 90° straight up, 180° to the left, and 270° straight down.

Rectangular form, on the other hand, is where a complex number is denoted by its respective horizontal and vertical components. In essence, the angled vector is taken to be the hypotenuse of a right triangle, described by the lengths of the adjacent and opposite sides. Rather than describing a vector's length and direction by denoting magnitude and angle, it is described in terms of its horizontal and vertical components.

In order to distinguish the horizontal and vertical dimensions from each other, the vertical is prefixed with a lower-case "j".

This lower-case letter does not represent a physical variable but rather a mathematical "operator" used to distinguish the phasor's vertical component from its horizontal component. As a complete complex number, the horizontal and vertical quantities are written as a sum:

In "rectangular" form, a vector's length and direction are denoted in terms of its horizontal and vertical span, the first number representing the horizontal ("real") and the second number (with the "j" prefix) representing the vertical ("imaginary") dimensions.

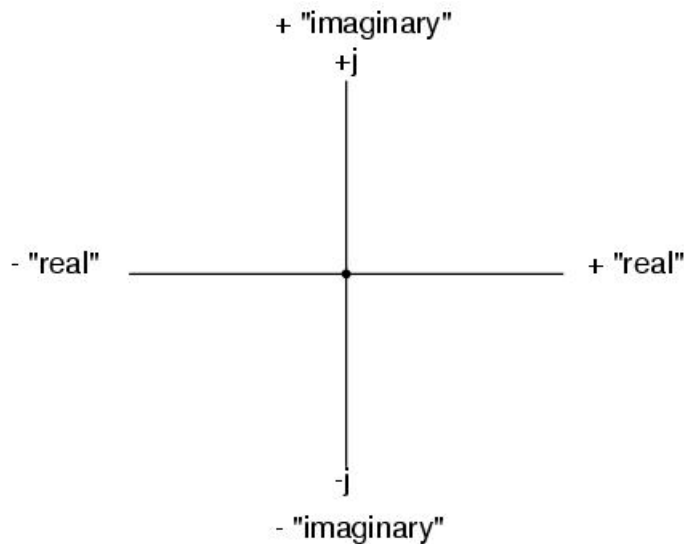
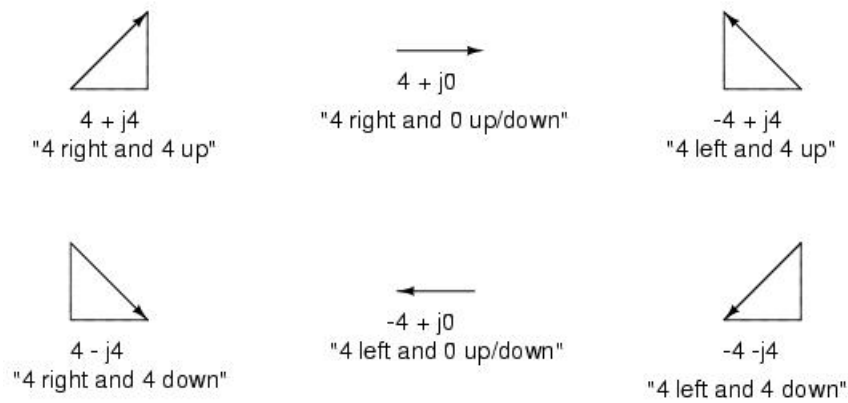

The horizontal component is referred to as the *real* component, since that dimension is compatible with normal, scalar ("real") numbers. The vertical component is referred to as the *imaginary* component, since that dimension lies in a different direction, totally alien to the scale of the real numbers. Phasors being two-dimensional entities must be expressed on a two-dimensional "map" thus the two number lines perpendicular to each other.

Either polar or rectangular method of notation is valid for complex numbers. The primary reason for having two methods of notation is for ease of longhand calculation, rectangular form lending itself to addition and subtraction, and polar form lending itself to multiplication and division.

Conversion between the two notational forms involves simple trigonometry as shown in the following figure:

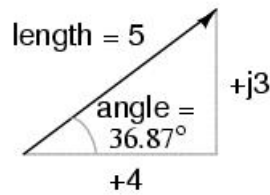

$$5 \angle 36.87^\circ \quad \text{(polar form)}$$

$$(5)(\cos 36.87^\circ) = 4 \quad \text{(real component)}$$

$$(5)(\sin 36.87^\circ) = 3 \quad \text{(imaginary component)}$$

$$4 + j3 \quad \text{(rectangular form)}$$

To convert from rectangular to polar we carry out the following:

$$4 + j3 \quad \text{(rectangular form)}$$

$$c = \sqrt{a^2 + b^2} \quad \text{(pythagorean theorem)}$$

$$\text{polar magnitude} = \sqrt{4^2 + 3^2}$$

$$\text{polar magnitude} = 5$$

$$\text{polar angle} = \arctan \frac{3}{4}$$

$$\text{polar angle} = 36.87^\circ$$

$$5 \angle 36.87^\circ \quad \text{(polar form)}$$

Section Review:

- *Polar* notation denotes a complex number in terms of its magnitude and angular direction from the reference axis.
- *Rectangular* notation denotes a complex number in terms of its horizontal and vertical components.
- In rectangular notation, the first quantity is the "real" component (horizontal dimension of vector) and the second quantity is the "imaginary" component (vertical dimension of vector). The imaginary component is preceded by a lower-case "j," sometimes called the "j operator."

2.6 Complex Number Arithmetic

[This material relates predominantly to module ELP032]

Since complex numbers are legitimate mathematical entities, just like scalar numbers, they can be added, subtracted, multiplied, divided, squared, inverted, just like any other kind of number. Some scientific calculators are programmed to directly perform these operations on two or more complex numbers, but these operations can also be done "by hand."

Addition and subtraction with complex numbers in rectangular form is easy. For addition, simply add up the real components of the complex numbers to determine the real component of the sum, and add up the imaginary components of the complex numbers to determine the imaginary component of the sum:

$$\begin{array}{r} 2 + j5 \\ + 4 - j3 \\ \hline 6 + j2 \end{array} \qquad \begin{array}{r} 175 - j34 \\ + 80 - j15 \\ \hline 255 - j49 \end{array} \qquad \begin{array}{r} -36 + j10 \\ + 20 + j82 \\ \hline -16 + j92 \end{array}$$

When subtracting complex numbers in rectangular form, simply subtract the real component of the second complex number from the real component of the first to arrive at the real component of the difference, and subtract the imaginary component of the second complex number from the imaginary component of the first to arrive at the imaginary component of the difference:

$$\begin{array}{r} 2 + j5 \\ - 4 - j3 \\ \hline -2 + j8 \end{array} \qquad \begin{array}{r} 175 - j34 \\ - 80 - j15 \\ \hline 95 - j19 \end{array} \qquad \begin{array}{r} -36 + j10 \\ - 20 + j82 \\ \hline -56 - j72 \end{array}$$

For longhand multiplication and division, polar is the favored notation to work with. When multiplying complex numbers in polar form, simply *multiply* the polar magnitudes of the complex numbers to determine the polar magnitude of the product, and *add* the angles of the complex numbers to determine the angle of the product:

$$\begin{aligned} (35 \angle 65^\circ)(10 \angle -12^\circ) &= 350 \angle 53^\circ \\ (124 \angle 250^\circ)(11 \angle 100^\circ) &= 1364 \angle -10^\circ \\ &\text{or} \\ &1364 \angle 350^\circ \\ (3 \angle 30^\circ)(5 \angle -30^\circ) &= 15 \angle 0^\circ \end{aligned}$$

Division of polar-form complex numbers is also easy: simply divide the polar magnitude of the first complex number by the polar magnitude of the second complex number to arrive at the polar magnitude of the quotient, and subtract the angle of the second complex number from the angle of the first complex number to arrive at the angle of the quotient:

$$\frac{35 \angle 65^\circ}{10 \angle -12^\circ} = 3.5 \angle 77^\circ$$

$$\frac{124 \angle 250^\circ}{11 \angle 100^\circ} = 11.273 \angle 150^\circ$$

$$\frac{3 \angle 30^\circ}{5 \angle -30^\circ} = 0.6 \angle 60^\circ$$

To obtain the reciprocal, or "invert" ($1/x$), a complex number, simply divide the number (in polar form) into a scalar value of 1, which is nothing more than a complex number with no imaginary component (angle = 0):

$$\frac{1}{35 \angle 65^\circ} = \frac{1 \angle 0^\circ}{35 \angle 65^\circ} = 0.02857 \angle -65^\circ$$

$$\frac{1}{10 \angle -12^\circ} = \frac{1 \angle 0^\circ}{10 \angle -12^\circ} = 0.1 \angle 12^\circ$$

$$\frac{1}{0.0032 \angle 10^\circ} = \frac{1 \angle 0^\circ}{0.0032 \angle 10^\circ} = 312.5 \angle -10^\circ$$

These are the basic operations you will need to know in order to manipulate complex numbers in the analysis of AC circuits.

Section Review:

- To add complex numbers in rectangular form, add the real components and add the imaginary components. Subtraction is similar.
- To multiply complex numbers in polar form, multiply the magnitudes and add the angles. To divide, divide the magnitudes and subtract one angle from the other.

2.7 Some Examples with AC Circuits

Let's connect three AC voltage sources in series and use complex numbers to determine additive voltages. All the rules and laws learned in the study of DC circuits apply to AC circuits as well (Ohm's Law, Kirchhoff's Laws, network analysis methods), with the exception of power calculations (a topic to be dealt with later). The only qualification is that all variables *must* be expressed in complex form, taking into account phase as well as magnitude, and all voltages and currents must be of the same frequency (in order that their phase relationships remain constant).

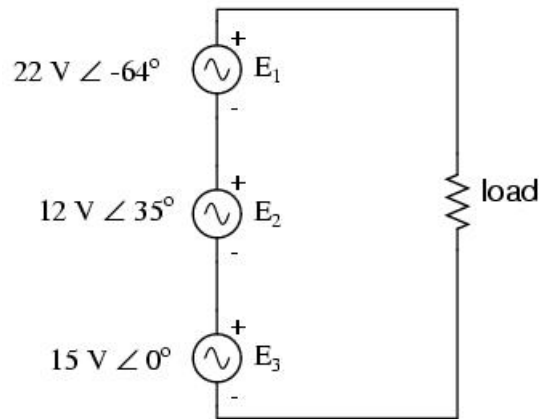

The polarity marks for all three voltage sources are oriented in such a way that their stated voltages should add to make the total voltage across the load resistor. The set-up of our equation to find total voltage appears as such:

$$E_{\text{total}} = E_1 + E_2 + E_3$$

$$E_{\text{total}} = (22 \text{ V } \angle -64^\circ) + (12 \text{ V } \angle 35^\circ) + (15 \text{ V } \angle 0^\circ)$$

Graphically, the phasors add up in this manner:

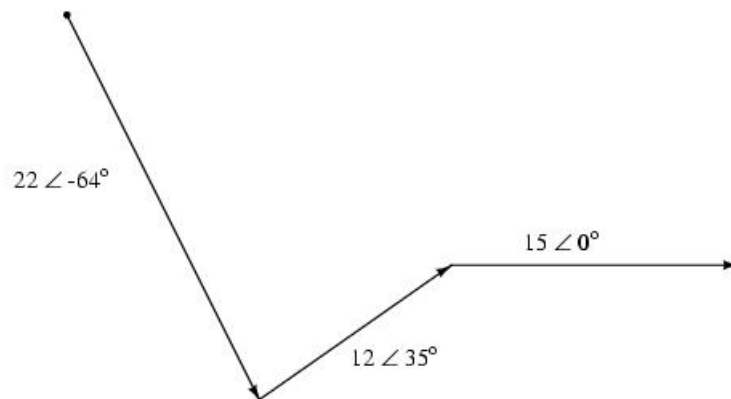

The sum of these phasors will be a resultant phasor originating at the starting point for the 22 volt phasor (dot at upper-left of diagram) and terminating at the ending point for the 15 volt phasor (arrow tip at the middle-right of the diagram):

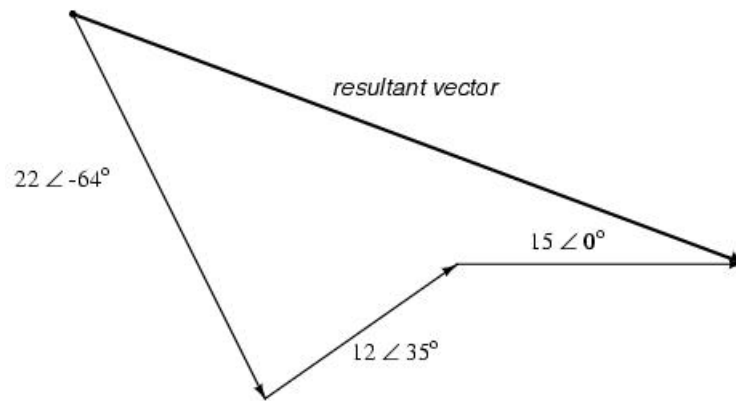

In order to determine what the resultant phasor's magnitude and angle are without resorting to graphic images, we can convert each one of these polar-form complex numbers into rectangular form and add. Remember, we're *adding* these figures together because the polarity marks for the three voltage sources are oriented in an additive manner:

$$\begin{aligned}
 15 \text{ V } \angle 0^\circ &= 15 + j0 \text{ V} \\
 12 \text{ V } \angle 35^\circ &= 9.8298 + j6.8829 \text{ V} \\
 22 \text{ V } \angle -64^\circ &= 9.6442 - j19.7735 \text{ V} \\
 \\
 \begin{array}{r}
 15 \quad + j0 \quad \text{V} \\
 9.8298 \quad + j6.8829 \text{ V} \\
 + 9.6442 \quad - j19.7735 \text{ V} \\
 \hline
 \mathbf{34.4740 - j12.8906 \text{ V}}
 \end{array}
 \end{aligned}$$

In polar form, this equates to 36.8052 volts $\angle -20.5018^\circ$. What this means in real terms is that the voltage measured across these three voltage sources will be 36.8052 volts, lagging the 15 volt (0° phase reference) by 20.5018° . A voltmeter connected across these points in a real circuit would only indicate the polar magnitude of the voltage (36.8052 volts), not the angle. An oscilloscope could be used to display two voltage waveforms and thus provide a phase shift measurement, but not a voltmeter. The same principle holds true for AC ammeters: they indicate the polar magnitude of the current, not the phase angle.

This is extremely important in relating calculated figures of voltage and current to real circuits. Although rectangular notation is convenient for addition and subtraction, and was indeed the final step in our sample problem here, it is not immediately applicable to practical measurements. Rectangular figures must be converted to polar figures (specifically polar *magnitude*) before they can be related to actual circuit measurements.

Section Review:

- All the laws and rules of DC circuits apply to AC circuits, with the exception of power calculations, so long as all values are expressed and manipulated in complex form, and all voltages and currents are at the same frequency.
- Meter measurements in an AC circuit correspond to the *polar magnitudes* of calculated values.

3. The Concept of Impedance

3.1 AC Resistor Circuits

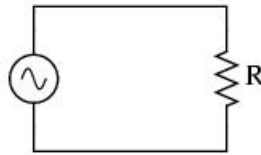

If we were to plot the current and voltage for a very simple AC circuit consisting of a source and a resistor, it would look something like this:

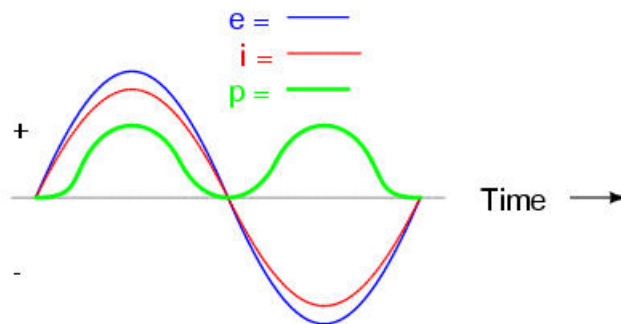

Because the resistor simply and directly resists the flow of electrons at all periods of time, the waveform for the voltage drop across the resistor is exactly in phase with the waveform for the current through it. At any instant the current 'i' is given from ohm's law by

$$i = v/R$$

We can also calculate the instantaneous power 'p' dissipated by this resistor from $p = Ri^2$, and plot those values on the same graph.

Note that the power is always positive, i.e. the resistor acts at all times as a load or a 'sink' of energy converting irreversibly electrical into thermal energy.

3.2 AC Inductor Circuits

Whereas resistors simply oppose the flow of electrons through them (by dropping a voltage directly proportional to the current), inductors oppose *changes* in current through them, by dropping a voltage directly proportional to the *rate of change* of current. This opposition to current change is called *reactance*, rather than resistance.

The 'ohm's' law for an inductor is given by

$$e = L \frac{di}{dt}$$

To show what happens with alternating current, let's analyse a simple inductor circuit:



If we were to plot the current and voltage for this very simple circuit, it would look something like this:

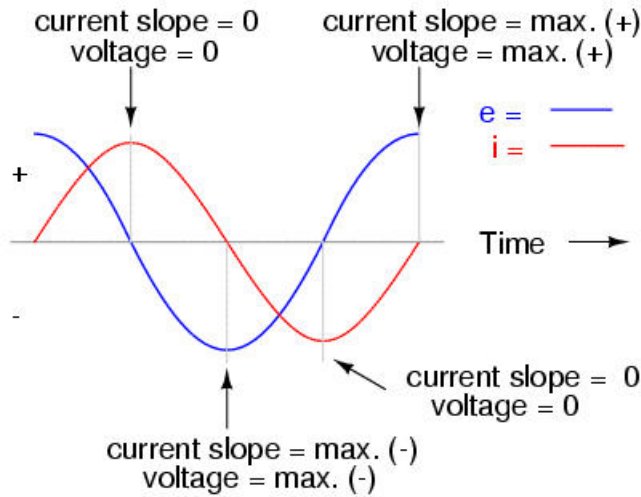

Remember, the voltage dropped across an inductor is a reaction against the *change* in current through it. This results in a voltage wave that is 90° out of phase with the current wave. Looking at the graph, the voltage wave has a "head start" on the current wave; the voltage "leads" the current, and the current "lags" behind the voltage.

Things get even more interesting when we plot the instantaneous power for this circuit using the expression $p=ei$:

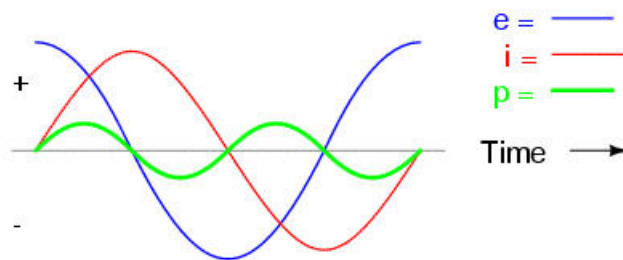

Because instantaneous power is the product of the instantaneous voltage and the instantaneous current ($p=ei$), the power equals zero whenever the instantaneous current *or* voltage is zero. Whenever the instantaneous current and voltage are both positive (above the line), the power is positive. As with the resistor example, the power is also positive when the instantaneous current and voltage are both negative (below the line). However, because the current and voltage waves are 90° out of phase, there are times when one is positive while the other is negative, resulting in equally frequent occurrences of *negative instantaneous power*. In FE-1 we established the fact that negative power associated with a circuit element implies 'generation' rather than 'consumption' of power. This means that the inductor, at times, is acting as a source releasing power back to the circuit.

Since the positive and negative power cycles are equal in magnitude and duration over time, the inductor releases just as much power back to the circuit as it absorbs over the span of a complete cycle. What this means in a practical sense is that the reactance of an inductor dissipates a net energy of zero, quite unlike the resistance of a resistor, which dissipates energy in the form of heat. Mind you, this is for perfect inductors only, which have no wire resistance.

If we assume a current waveform that is sinusoidal and we substitute this into the 'ohm's' equation for the inductor, we get

$$V = L \frac{d(I \sin \omega t)}{dt} = \omega L \cos \omega t = X_L \cos \omega t \quad \text{where} \quad X_L = 2\pi f L$$

The inductor's opposition to alternating current ($X_L = 2\pi f L$) is similar to resistance, but different in that it always results in a phase shift between current and voltage, and it dissipates zero net power. Because of the differences, it has a different name: *reactance*. Reactance to AC is expressed in ohms, just like resistance is, except that its mathematical symbol is X instead of R.

AC current in a simple inductive circuit is equal to the voltage (in volts) divided by the inductive reactance (in ohms), just as AC or DC current in a simple resistive circuit is equal to the voltage (in volts) divided by the resistance (in ohms).



(inductive reactance of 10 mH inductor at 60 Hz)

$$X_L = 3.7699 \Omega$$

$$I = \frac{E}{X}$$

$$I = \frac{10 \text{ V}}{3.7699 \Omega}$$

$$I = 2.6526 \text{ A}$$

However, we need to keep in mind that voltage and current are not in phase here. As was shown earlier, the voltage has a phase shift of $+90^\circ$ with respect to the current. If we represent these phase angles of voltage and current mathematically in the form of complex numbers, we find that an inductor's opposition to current has a phase angle, too:

$$\text{Opposition} = \frac{\text{Voltage}}{\text{Current}}$$

$$\text{Opposition} = \frac{10 \text{ V } \angle 90^\circ}{2.6526 \text{ A } \angle 0^\circ}$$

$$\text{Opposition} = 3.7699 \Omega \angle 90^\circ$$

or

$$0 + j3.7699 \Omega$$

For an inductor:

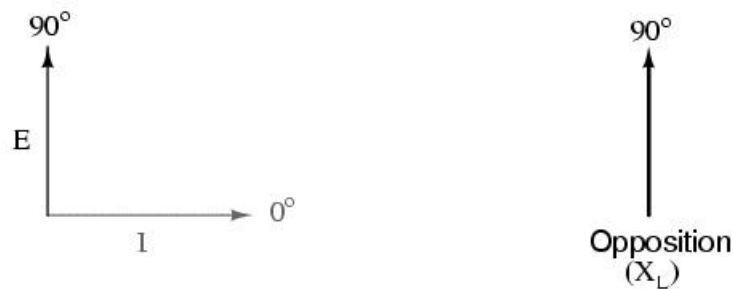

Mathematically, we say that the phase angle of an inductor's opposition to current is 90° , meaning that an inductor's opposition to current is a positive imaginary quantity. This phase angle of reactive opposition to current becomes critically important in circuit analysis, especially for complex AC circuits where reactance and resistance interact. It will prove beneficial to represent *any* component's opposition to current in terms of complex numbers rather than scalar quantities of resistance and reactance.

Section Review:

- *Inductive reactance* is the opposition that an inductor offers to alternating current due to its phase-shifted storage and release of energy in its magnetic field. Reactance is symbolised by the capital letter "X" and is measured in ohms just like resistance.
- Inductive reactance can be calculated using this formula: $X_L = 2\pi fL$
- Inductive reactance *increases* with increasing frequency.

3.3 Series Resistor-Inductor Circuits

In the previous section, we explored what would happen in simple resistor-only and inductor-only AC circuits. Now we will mix the two components together in series form and investigate the effects.

Take this circuit as an example to work with:

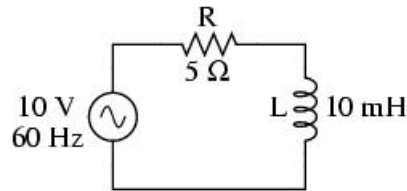

The resistor will offer 5 ohm of resistance to AC current regardless of frequency, while the inductor will offer 3.7699 ohm of reactance to AC current at 60 Hz (check this through your own calculation). Because the resistor's resistance is a real number and the inductor's reactance is an imaginary number the combined effect of the two components will be an opposition to current equal to the complex sum of the two numbers. This combined opposition will be a phasor combination of resistance and reactance. In order to express this opposition succinctly, we need a more comprehensive term for opposition to current than either resistance or reactance alone. This term is called *impedance*, its symbol is Z , and it is also expressed in the unit of ohms, just like resistance and reactance. In the above example, the total circuit impedance is:

$$Z_{\text{total}} = (5 \Omega \text{ resistance}) + (3.7699 \Omega \text{ inductive reactance})$$

$$Z_{\text{total}} = 5 \Omega (R) + 3.7699 \Omega (X_L)$$

$$Z_{\text{total}} = (5 \Omega \angle 0^\circ) + (3.7699 \Omega \angle 90^\circ)$$

or

$$(5 + j0 \Omega) + (0 + j3.7699 \Omega)$$

$$Z_{\text{total}} = 5 + j3.7699 \Omega \quad \text{or} \quad 6.262 \Omega \angle 37.016^\circ$$

Impedance is related to voltage and current just as you might expect, in a manner similar to resistance in Ohm's Law:

Ohm's Law for AC circuits:

$$\mathbf{E} = \mathbf{I}Z \quad \mathbf{I} = \frac{\mathbf{E}}{\mathbf{Z}} \quad \mathbf{Z} = \frac{\mathbf{E}}{\mathbf{I}}$$

All quantities expressed in complex, not scalar, form

In fact, this is a far more comprehensive form of Ohm's Law than what was taught in unit FE-1, just as impedance is a far more comprehensive expression of opposition to the flow

of electrons than resistance is. *Any* resistance and any reactance, separately or in combination (series/parallel), can be and should be represented as a single impedance in an AC circuit.

To calculate current in the above circuit, we first need to give a phase angle reference for the voltage source, which is generally assumed to be zero. (The phase angles of resistive and inductive impedance are *always* 0° and $+90^\circ$, respectively, regardless of the given phase angles for voltage or current).

$$I = \frac{E}{Z}$$

$$I = \frac{10 \text{ V } \angle 0^\circ}{6.262 \text{ } \Omega \angle 37.016^\circ}$$

$$I = 1.597 \text{ A } \angle -37.016^\circ$$

As with the purely inductive circuit, the current wave lags behind the voltage wave (of the source), although this time the lag is not as great: only 37.016° as opposed to a full 90° as was the case in the purely inductive circuit.

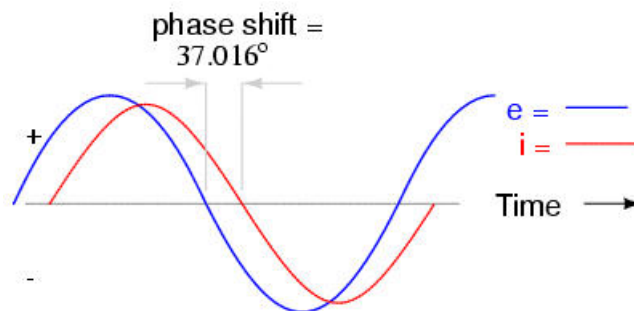

For the resistor and the inductor, the phase relationships between voltage and current haven't changed. The voltage across the resistor is in phase (0° shift) with the current through it; and the voltage across the inductor is $+90^\circ$ out of phase with the current going through it. We can verify this mathematically:

$$E = IZ$$

$$E_R = I_R Z_R$$

$$E_R = (1.597 \text{ A } \angle -37.016^\circ)(5 \text{ } \Omega \angle 0^\circ)$$

$$E_R = 7.9847 \text{ V } \angle -37.016^\circ$$

Notice that the phase angle of E_R is equal to the phase angle of the current.

The voltage across the resistor has the exact same phase angle as the current through it, telling us that E and I are in phase (for the resistor only).

$$E = IZ$$

$$E_L = I_L Z_L$$

$$E_L = (1.597 \text{ A } \angle -37.016^\circ)(3.7699 \text{ } \Omega \angle 90^\circ)$$

$$E_L = 6.0203 \text{ V } \angle 52.984^\circ$$

Notice that the phase angle of E_L is exactly 90° more than the phase angle of the current.

The voltage across the inductor has a phase angle of 52.984° , while the current through the inductor has a phase angle of -37.016° , a difference of exactly 90° between the two. This tells us that E and I are still 90° out of phase (for the inductor only).

We can also mathematically prove that these complex values add together to make the total voltage, just as Kirchhoff's Voltage Law would predict.

Exercise

Add phasorially the voltage across the resistor to that across the inductor to show that it is equal to the supply voltage.

Section Review:

- *Impedance* is the total measure of opposition to electric current and is the complex sum of ("real") resistance and ("imaginary") reactance. It is symbolized by the letter "Z" and measured in ohms, just like resistance (R) and reactance (X).
- Impedances (Z) are managed just like resistances (R) in series circuit analysis: series impedances add to form the total impedance $Z_{\text{Total}} = Z_1 + Z_2 + \dots + Z_n$
- A purely resistive impedance will always have a phase angle of exactly 0°
- A purely inductive impedance will always have a phase angle of exactly $+90^\circ$
- Ohm's Law for AC circuits: $E = IZ$; $I = E/Z$; $Z = E/I$
- When resistors and inductors are mixed together in circuits, the total impedance will have a phase angle somewhere between 0° and $+90^\circ$. The circuit current will have a phase angle somewhere between 0° and -90° .
- Series AC circuits exhibit the same fundamental properties as series DC circuits: current is the same throughout the circuit, voltage drops add to form the total voltage, and impedances add to form the total impedance.

3.4 Parallel Resistor-Inductor Circuits

Let's take the same components for our series example circuit and connect them in parallel:

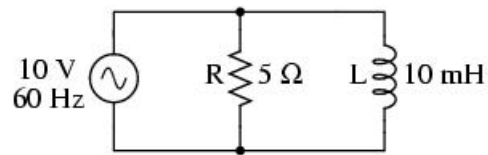

Because the power source has the same frequency as the series example circuit, and the resistor and inductor both have the same values of resistance and inductance, respectively, they must also have the same values of impedance. Here the complex currents through the resistive and inductive branches can be calculated separately and added to arrive at the current provided by the AC source. Alternatively the overall impedance seen by the source can be calculated using a reciprocal formula identical to that used in calculating parallel resistances.

$$Z_{\text{parallel}} = \frac{1}{\frac{1}{Z_1} + \frac{1}{Z_2} + \dots + \frac{1}{Z_n}}$$

The supply current is then the source voltage divided by the overall impedance.

Exercise

Using the two methods outlined above, calculate the source current. Both methods should provide the same answer ($I=2-j2.6526$)

Section Review:

- Impedances (Z) are managed just like resistances (R) in parallel circuit analysis: Just be sure to perform all calculations in complex form!
- When resistors and inductors are mixed together in parallel circuits (just as in series circuits), the total impedance will have a phase angle somewhere between 0° and $+90^\circ$. The circuit current will have a phase angle somewhere between 0° and -90° .
- Parallel AC circuits exhibit the same fundamental properties as parallel DC circuits: voltage is uniform throughout the circuit, branch currents add to form the total current, and impedances diminish (through the reciprocal formula) to form the total impedance.

3.5 More on Inductors

[This material relates predominantly to module ELP032]

In an ideal case, an inductor acts as a purely reactive device. However, inductors are not quite so pure in their reactive behaviour. To begin with, they're made of wire, and we know that all wire possesses some measurable amount of resistance (unless it's superconducting wire). This built-in resistance acts as though it were connected in series with the perfect inductance of the coil. Consequently, the impedance of any real inductor will always be a complex combination of resistance and inductive reactance.

Compounding this problem is something called the *skin effect*, which is AC's tendency to flow through the outer areas of a conductor's cross-section rather than through the middle. When electrons flow in a single direction (DC), they use the entire cross-sectional area of the conductor to move. Electrons switching directions of flow, on the other hand, tend to avoid travel through the very middle of a conductor, limiting the effective cross-sectional area available. The skin effect becomes more pronounced at higher frequencies but even at power frequencies it increases the effective resistance and the 'copper' losses of conductors.

Added to the resistive losses of wire, there are other effects at work in iron-core inductors, which manifest themselves as additional circuit resistance. When an inductor is energised with AC, the alternating magnetic fields produced tend to induce circulating currents within the iron core known as *eddy currents*. Eddy current losses are primarily counteracted by dividing the iron core up into many thin sheets (laminations), each one separated from the other by a thin layer of electrically insulating varnish. With the cross-section of the core divided up into many electrically isolated sections, current has limited circulation within that cross-sectional area and losses are substantially reduced. All AC electrical machines that rely on magnetics (generators motors and transformers) have laminated cores.

Additionally, any magnetic hysteresis of the core that needs to be overcome with every reversal of the inductor's magnetic field constitutes an expenditure of energy that manifests itself as resistance in the circuit. Counteracting this effect is best done by means of proper core material selection and limits on the peak magnetic field intensity generated with each cycle.

Altogether, the stray resistive properties of a real inductor (wire resistance, eddy currents, and hysteresis losses) are expressed under the single term of "effective resistance:"

Equivalent circuit for a real inductor

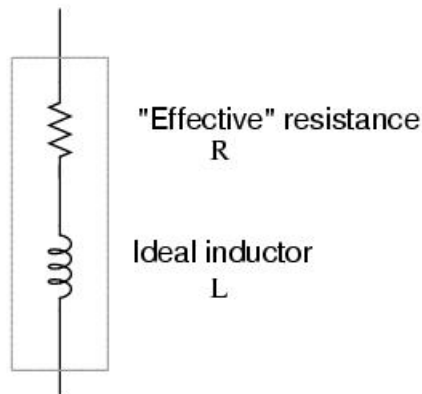

3.6 AC Capacitor Circuits

Whereas resistors allow a flow of electrons through them directly proportional to the voltage drop, capacitors oppose *changes* in voltage by drawing or supplying current as they charge or discharge to the new voltage level. The flow of electrons "through" a capacitor is directly proportional to the *rate of change* of voltage across the capacitor. This opposition to voltage change is another form of *reactance*, but one that is a mirror image of the kind exhibited by inductors.

Expressed mathematically, the relationship between the current "through" the capacitor and rate of voltage change across the capacitor is:

$$i = C \frac{dv}{dt}$$

The capacitance (C) is in Farads, and the instantaneous current (i), is in amps. To show what happens with alternating current, let's analyse a simple capacitor circuit:

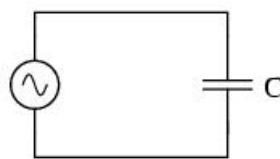

If we were to plot the current and voltage for this very simple circuit, it would look something like this:

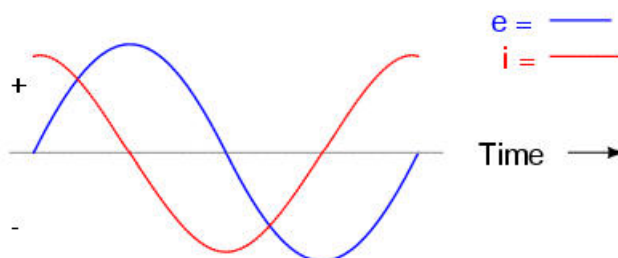

Remember, the current through a capacitor is a reaction against the *change* in voltage across it. Therefore, the instantaneous current is zero whenever the instantaneous voltage is at a peak (zero change, or level slope, on the voltage sine wave), and the instantaneous current is at a peak wherever the instantaneous voltage is at maximum change (the points of steepest slope on the voltage wave, where it crosses the zero line). This results in a voltage wave that is -90° out of phase with the current wave. Looking at the graph, the current has a "head start" on the voltage wave i.e. the current "leads" the voltage, and the voltage "lags" the current.

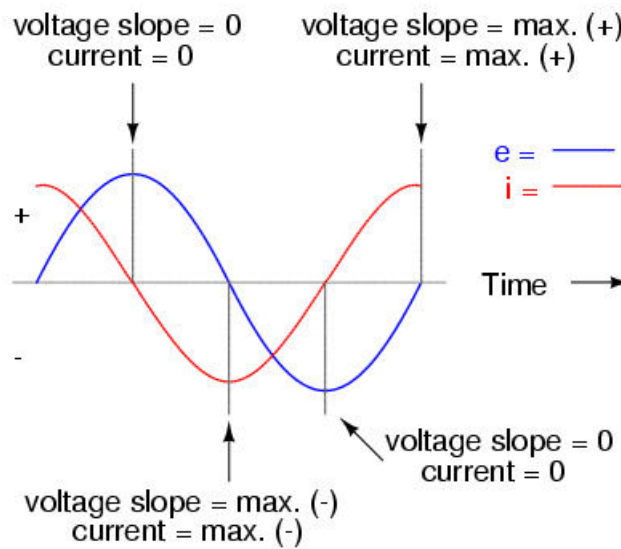

As you might have guessed, the same unusual power wave that we saw with the simple inductor circuit is present in the simple capacitor circuit, too:

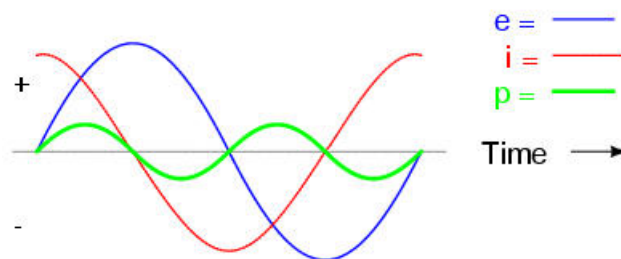

As with the simple inductor circuit, the 90 degree phase shift between voltage and current results in a power wave that alternates equally between positive and negative. This means that a capacitor does not dissipate power as it reacts against changes in voltage; it merely absorbs and releases power, alternately.

A capacitor's opposition to change in voltage translates to an opposition to alternating voltage in general, which is by definition always changing in instantaneous magnitude and direction. For any given magnitude of AC voltage at a given frequency, a capacitor of given size will allow the flow of a certain magnitude of AC current given by the following:

$$\begin{aligned}
 i &= C \frac{dv}{dt} \\
 &= Cd(V\sin\omega t)/dt = \omega CV\cos\omega t = (V/X_c)\cos\omega t, \text{ where} \\
 X_c &= \frac{1}{2\pi fC}
 \end{aligned}$$

Just as the current through a resistor is a function of the voltage across the resistor and the resistance offered by the resistor, the AC current through a capacitor is a function of the AC voltage across it, and the *reactance* X_c offered by the capacitor.

Since capacitors "conduct" current in proportion to the rate of voltage change, they will pass more current for voltages of higher frequency.

AC current in a simple capacitive circuit is equal to the voltage (in volts) divided by the capacitive reactance (in ohms).

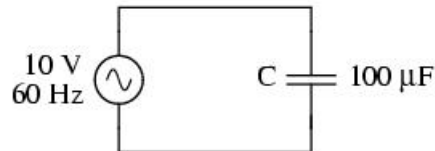

$$X_c = 26.5258 \Omega$$

$$I = \frac{E}{X}$$

$$I = \frac{10 \text{ V}}{26.5258 \Omega}$$

$$I = 0.3770 \text{ A}$$

However, we need to keep in mind that voltage and current are not in phase here. As was shown earlier, the current has a phase shift of $+90^\circ$ with respect to the voltage. If we represent these phase angles of voltage and current mathematically, we can calculate the phase angle of the inductor's reactive opposition to current.

$$\text{Opposition} = \frac{\text{Voltage}}{\text{Current}}$$

$$\text{Opposition} = \frac{10 \text{ V} \angle 0^\circ}{0.3770 \text{ A} \angle 90^\circ}$$

$$\text{Opposition} = 26.5258 \Omega \angle -90^\circ$$

For a capacitor:

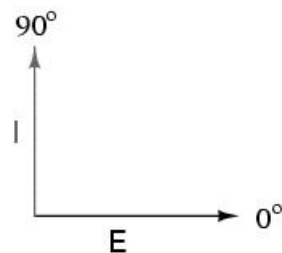

Mathematically, we say that the phase angle of a capacitor's opposition to current is -90° , meaning that a capacitor's opposition to current is a negative imaginary quantity. This phase angle of reactive opposition to current becomes critically important in circuit analysis, especially for complex AC circuits where reactance and resistance interact.

Section Review:

- *Capacitive reactance* is the opposition that a capacitor offers to alternating current due to its phase-shifted storage and release of energy in its electric field.
- Capacitive reactance can be calculated using this formula:

$$X_C = \frac{1}{2\pi fC}$$

- Capacitive reactance *decreases* with increasing frequency.

3.7 Series Resistor-Capacitor Circuits

Take this circuit as an example to analyse:

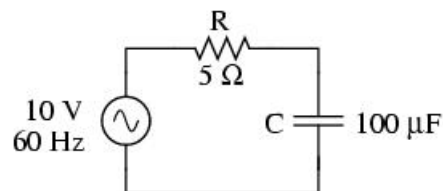

The resistor will offer 5 ohm of resistance to AC current regardless of frequency, while the capacitor will offer 26.5258 ohms of reactance to AC current at 60 Hz (check this through your own calculation). Because the resistor's resistance is a real number and the capacitor's reactance is an imaginary number the combined effect of the two components will be an opposition to current equal to the complex sum of the two numbers. The term for this complex opposition to current (as in the series RL circuit) is the *impedance* Z . In the above example, the total circuit impedance is:

$$Z_{\text{total}} = (5 \Omega \text{ resistance}) + (26.5258 \Omega \text{ capacitive reactance})$$

$$Z_{\text{total}} = 5 \Omega (R) + 26.5258 \Omega (X_C)$$

$$Z_{\text{total}} = (5 \Omega \angle 0^\circ) + (26.5258 \Omega \angle -90^\circ)$$

or

$$(5 + j0 \Omega) + (0 - j26.5258 \Omega)$$

$$Z_{\text{total}} = 5 - j26.5258 \Omega \quad \text{or} \quad 26.993 \Omega \angle -79.325^\circ$$

To calculate current in the above circuit, we first need to give a phase angle reference for the voltage source, which is generally assumed to be zero. (The phase angles of resistive and capacitive impedance are *always* 0° and -90° , respectively, regardless of the given phase angles for voltage or current).

$$I = \frac{E}{Z}$$

$$I = \frac{10 \text{ V } \angle 0^\circ}{26.933 \Omega \angle -79.325^\circ}$$

$$I = 370.5 \text{ mA } \angle 79.325^\circ$$

As with the purely capacitive circuit, the current wave is leading the voltage wave (of the source), although this time the difference is 79.325° instead of a full 90° .

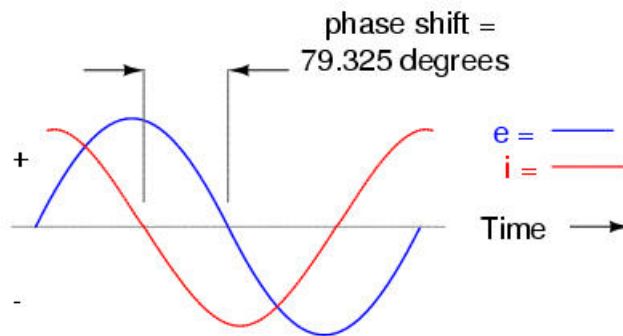

Section Review:

- A purely capacitive impedance will always have a phase angle of exactly -90°
- When resistors and capacitors are mixed together in circuits, the total impedance will have a phase angle somewhere between 0° and -90° .

3.8 Parallel Resistor-Capacitor Circuits

Using the same value components in our series example circuit, we will connect them in parallel and see what happens:

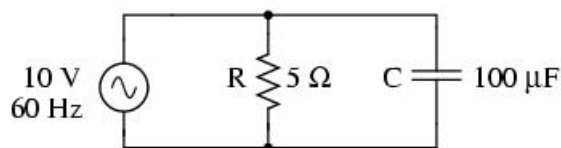

This being a parallel circuit now, we know that voltage is shared equally by all components,

Now we can apply Ohm's Law ($I=E/Z$) calculating current through the resistor and current through the capacitor:

Just as with DC circuits, branch currents in a parallel AC circuit add up (phasorially) to form the total current (Kirchhoff's Current Law again):

As we saw in the section dealing with parallel RL circuit, parallel impedance can also be calculated by using a reciprocal formula identical to that used in calculating parallel resistances. It is noteworthy to mention that this parallel impedance rule holds true

regardless of the kind of impedances placed in parallel. In other words, it doesn't matter if we're calculating a circuit composed of parallel resistors, parallel inductors, parallel capacitors, or some combination thereof: in the form of impedances (Z), all the terms are common and can be applied uniformly to the same formula.

The only drawback to using this equation is the significant amount of work required to work it out, especially without the assistance of a calculator capable of manipulating complex quantities. Regardless of how we calculate total impedance for our parallel circuit (either Ohm's Law or the reciprocal formula), we will arrive at the same figure:

Exercise

Using the two methods outlined above, calculate the source current. Both methods should provide the same answer ($I=2+j0.377$ A)

Section Review:

- Impedances (Z) are managed just like resistances (R) in parallel circuit analysis:
- When resistors and capacitors are mixed together in parallel circuits (just as in series circuits), the total impedance will have a phase angle somewhere between 0° and -90° . The circuit current will have a phase angle somewhere between 0° and $+90^\circ$.
- Parallel AC circuits exhibit the same fundamental properties as parallel DC circuits: voltage is uniform throughout the circuit, branch currents add phasorially to form the total current, and impedances diminish (through the reciprocal formula) to form the total impedance.

3.9 More on Capacitors

As with inductors, the ideal capacitor is a purely reactive device, containing absolutely zero resistive (power dissipative) effects. In the real world, of course, nothing is so perfect. However, capacitors have the virtue of generally being *purier* reactive components than inductors. It is a lot easier to design and construct a capacitor with low internal series resistance than it is to do the same with an inductor. The practical result of this is that real capacitors typically have impedance phase angles more closely approaching 90° than inductors. Consequently, they will tend to dissipate less power than an equivalent inductor.

Capacitors also tend to be smaller and lighter weight than their equivalent inductor counterparts, and since their electric fields are almost totally contained between their plates (unlike inductors, whose magnetic fields naturally tend to extend beyond the dimensions of the core), they are less prone to transmitting or receiving electromagnetic "noise" to/from other components. For these reasons, circuit designers tend to favour capacitors over inductors wherever a design permits either alternative.

Capacitors with significant resistive effects are said to be *lossy*, in reference to their tendency to dissipate ("lose") power like a resistor. The source of capacitor loss is usually the dielectric material rather than any wire resistance, as wire length in a capacitor is very minimal.

Dielectric materials tend to react to changing electric fields by producing heat. This heating effect represents a loss in power, and is equivalent to resistance in the circuit. The effect is more pronounced at higher frequencies.

4. Resonance and Other Topics

4.1 Resonance

[This material relates predominantly to modules ELP032, ELP041]

Capacitors store energy in the form of an electric field, and electrically manifest that stored energy as a potential: *static voltage*. Inductors store energy in the form of a magnetic field, and electrically manifest that stored energy as a kinetic motion of electrons: *current*. Capacitors and inductors are flip-sides of the same reactive coin, storing and releasing energy in complementary modes. When these two types of reactive components are directly connected together, their complementary tendencies to store energy will produce resonance.

If either the capacitor or inductor starts out in a charged state, the two components will exchange energy between them, back and forth, creating their own AC voltage and current cycles. The frequency of resonance is such that the inductive reactance is equal to the capacitive reactance, i.e.:

$$X_L = 2\pi fL =$$

$$X_C = \frac{1}{2\pi fC}$$

$$\text{i.e. at resonance } f = \frac{1}{2\pi\sqrt{LC}}$$

This oscillation will continue (undiminished in the theoretical case of no resistance) with steadily decreasing amplitude due to power losses from stray resistances in the circuit, until the process stops altogether. Overall, this behaviour is akin to that of a pendulum: as the pendulum mass swings back and forth, there is a transformation of energy taking place from kinetic (motion) to potential (height), in a similar fashion to the way energy is transferred in the capacitor/inductor circuit back and forth in the alternating forms of current (kinetic motion of electrons) and voltage (potential electric energy).

This tendency to oscillate, or *resonate*, at a particular frequency is not limited to circuits exclusively designed for that purpose. In fact, nearly any AC circuit with a combination of capacitance and inductance (commonly called an "LC circuit") will tend to resonate under certain conditions. Such resonances may develop voltages across the reactive elements, which are much higher than the source voltage that initiated the resonance in the first place. These effects are of importance in power systems where unwanted resonances may cause maloperation or damage to equipment.

Section Review:

- A capacitor and inductor in a circuit if excited may resonate at one particular frequency. At that frequency, energy is alternately shuffled between the capacitor and the inductor.
- Resonance may result in serious overvoltages that are damaging to equipment in power system networks.

4.2 Non-sinusoidal Waveforms

[This material relates predominantly to module ELP032]

In our study of AC circuits thus far, we've been looking at circuits powered by a single-frequency sine voltage waveform. In many applications of power electronics used in interfacing renewable energy converters into power networks, this is not the case. Quite often we may encounter circuits where multiple frequencies of voltage coexist simultaneously. Also, circuit waveforms may be something other than sine-wave shaped, in which case we call them *non-sinusoidal waveforms*.

It has been found that *any* repeating, non-sinusoidal waveform can be equated to a combination of DC voltage, sine waves, and/or cosine waves at various amplitudes and frequencies. This is true no matter how strange or convoluted the waveform in question may be. So long as it repeats itself regularly over time, it is reducible to this series of sinusoidal waves. In particular, it has been found that square waves are mathematically equivalent to the sum of a sine wave at that same frequency, plus an infinite series of odd-multiple frequency sine waves at diminishing amplitude:

1 V (peak) repeating square wave at 50 Hz is equivalent to:

$$\begin{aligned}
 & \left(\frac{4}{\pi}\right) (1 \text{ V peak sine wave at } 50 \text{ Hz}) \\
 & + \left(\frac{4}{\pi}\right) (1/3 \text{ V peak sine wave at } 150 \text{ Hz}) \\
 & + \left(\frac{4}{\pi}\right) (1/5 \text{ V peak sine wave at } 250 \text{ Hz}) \\
 & + \left(\frac{4}{\pi}\right) (1/7 \text{ V peak sine wave at } 350 \text{ Hz}) \\
 & + \left(\frac{4}{\pi}\right) (1/9 \text{ V peak sine wave at } 450 \text{ Hz}) \\
 & + \dots \textit{ ad infinitum} \dots
 \end{aligned}$$

The fact that repeating, non-sinusoidal waves are equivalent to a definite series of additive DC voltage, sine waves, and/or cosine waves is a consequence of how waves work: a fundamental property of all wave-related phenomenon, electrical or otherwise. The mathematical process of reducing a non-sinusoidal wave into these constituent frequencies is called *Fourier analysis*, the details of which are well beyond the scope of this text.

However, computer algorithms have been created to perform this analysis at high speeds on real waveforms, and its application in AC power quality and signal analysis is widespread.

This same technique of "Fourier Transformation" is often used in computerised power instrumentation, sampling the AC waveform(s) and determining the harmonic content thereof. A common computer algorithm (sequence of program steps to perform a task) for this is the *Fast Fourier Transform* or *FFT* function. You need not be concerned with exactly how these computer routines work, but be aware of their existence and application.

4.3 Non-linear Circuit Components

[This material relates predominantly to module ELP032]

Electronic power control devices such as transistors and thyristors often produce voltage and current waveforms that are essentially chopped-up versions of the otherwise "clean" (pure) sine-wave AC from the power supply. These devices have the ability to suddenly *change* their resistance with the application of a control signal voltage or current, thus "turning on" or "turning off" almost instantaneously, producing current waveforms bearing little resemblance to the source voltage waveform powering the circuit. These current waveforms then produce changes in the voltage waveform to other circuit components, due to voltage drops created by the non-sinusoidal current through circuit impedances.

Circuit components that distort the normal sine-wave shape of AC voltage or current are called *non-linear*. Non-linear components such as thyristors or power transistors find popular use in power electronics due to their ability to regulate large amounts of electrical power without dissipating much heat. While this is an advantage from the perspective of energy efficiency, the waveshape distortions they introduce can cause problems.

These non-sinusoidal waveforms, regardless of their actual shape, are equivalent to a series of sinusoidal waveforms of higher (harmonic) frequencies. It is becoming increasingly common in the electric power industry to observe overheating of transformers and motors due to distortions in the sine-wave shape of the AC power line voltage stemming from "switching" loads such as computers and high-efficiency lights and power electronic converters. This is no theoretical exercise: it is very real and potentially very troublesome.

One very common way harmonics are generated in an AC power system is when AC is converted, or "rectified" into DC. This is generally done with components called *diodes*, which only allow passage current in one direction. The simplest type of AC/DC rectification is *half-wave*, where a single diode blocks half of the AC current (over time) from passing through the load.

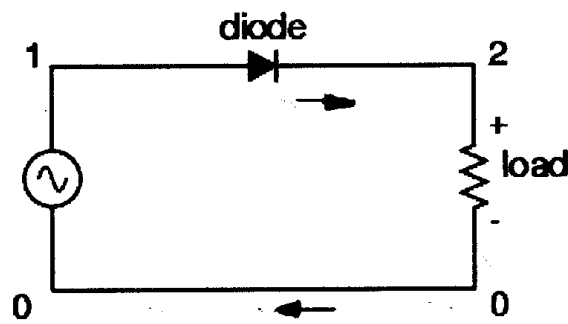

The diode only allows electron flow in a counter-clockwise direction.

By cutting out half of the AC wave, we've introduced the equivalent of several higher-frequency sinusoidal (actually, cosine) waveforms into our circuit from the original, pure sine-wave.

Another method of AC/DC conversion is called *full-wave*, which as you may have guessed utilises the full cycle of AC power from the source, reversing the polarity of half the AC cycle to get electrons to flow through the load the same direction all the time.

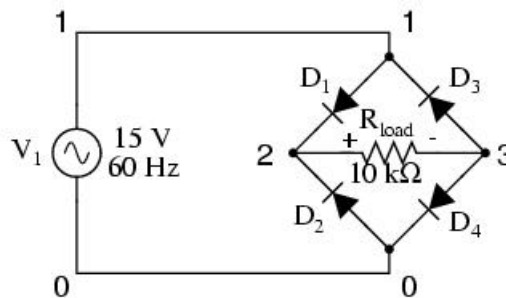

What may begin as a neat, simple AC sine-wave may end up as a complex mess of harmonics after passing through just a few electronic components. While the complex mathematics behind all this Fourier transformation is not necessary for the student to understand, it is of importance to realise the principles at work and to grasp the practical effects that harmonic signals may have on circuits. The practical effects of harmonic frequencies in circuits will be explored in the last section of this chapter, but before we do that we'll take a closer look at waveforms and their respective harmonics.

Section Review:

- Any waveform at all, so long as it is repetitive, can be reduced to a series of sinusoidal waveforms added together. Different waveshapes consist of different blends of sine-wave harmonics.
- Rectification of AC to DC is a very common source of harmonics within industrial power systems.

4.4 More on Spectrum Analysis

[This material relates predominantly to module ELP032]

The distinction between a waveform having even harmonics versus no even harmonics resides in the difference between a triangle waveshape and a sawtooth waveshape. That difference is *symmetry* above and below the horizontal centreline of the wave. A waveform that is symmetrical above and below its centreline (the shape on both sides mirror each other precisely) will contain *no* even-numbered harmonics.

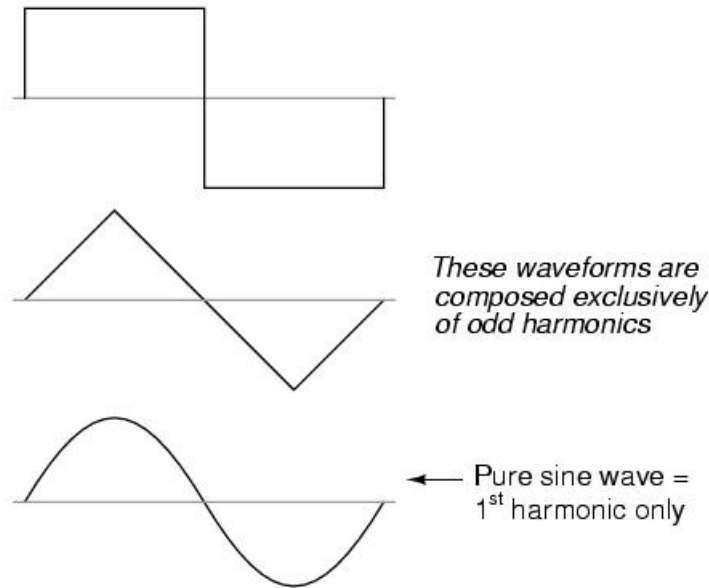

Square waves, triangle waves, and pure sine waves all exhibit this symmetry, and all are devoid of even harmonics. The following waveforms contain even harmonics:

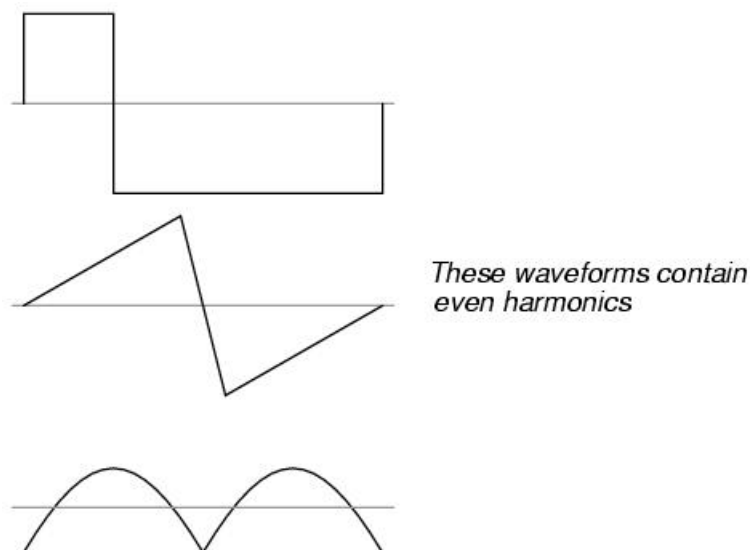

Why is this harmonic rule-of-thumb an important rule to know? It can help us comprehend the relationship between harmonics in AC circuits and specific circuit components. Since most sources of sine-wave distortion in AC power circuits tend to be symmetrical, even-

numbered harmonics are rarely seen in those applications. This is good to know if you're a power system designer and are planning ahead for harmonic reduction: you only have to concern yourself with mitigating the odd harmonic frequencies, even harmonics being practically non-existent in these cases.

Now that we have this rule to guide our interpretation of nonsinusoidal waveforms we can conclude that a waveform like that produced by a rectifier circuit contains strong even harmonics, there being no symmetry at all above and below centre.

Section Review:

- Waveforms that are symmetrical above and below their horizontal centrelines contain no even-numbered harmonics.

4.5 Circuit Effects

The principle of non-sinusoidal, repeating waveforms being equivalent to a series of sine waves at different frequencies is a fundamental property of waves in general and it has great practical import in the study of AC circuits. It means that any time we have a non-sinusoidal waveform; the circuit in question will react as though it's having an array of different frequency voltages imposed on it at once.

When an AC circuit is subjected to a source voltage consisting of a mixture of frequencies, the components in that circuit respond to each constituent frequency in a different way. Any reactive component such as a capacitor or an inductor will simultaneously present a unique amount of impedance to each and every frequency present in a circuit. Thankfully, the analysis of such (linear) circuits is made relatively easy by applying the *Superposition Theorem*, regarding the multiple-frequency source as a set of single-frequency voltage sources applied separately and in succession, and analysing the circuit for one source at a time, summing the results at the end to determine the aggregate total:

We can also apply the superposition theorem to the analysis of a circuit powered by a non-sinusoidal voltage, such as a square wave. If we know the Fourier series (multiple sine/cosine wave equivalent) of that wave, we can regard it as originating from a series-connected string of multiple sinusoidal voltage sources at the appropriate amplitudes, frequencies, and phase shifts. Needless to say, this can be a laborious task for some waveforms (an accurate square-wave Fourier Series is considered to be expressed out to the ninth harmonic, or five sine waves in all!), but it is possible. A real-life circuit will respond just the same to being powered by a square wave as being powered by an *infinite* series of sine waves of odd-multiple frequencies and diminishing amplitudes. This has been known to translate into unexpected circuit resonances, transformer and inductor core overheating due to eddy currents, electromagnetic noise over broad ranges of the frequency spectrum, and the like. Power engineers need to be made aware of the potential effects of non-sinusoidal waveforms in reactive circuits. These problems will be discussed in the module ELP032.

Section Review:

- Any regular (repeating), non-sinusoidal waveform is equivalent to a particular series of sine/cosine waves of different frequencies, phases, and amplitudes, plus possibly a DC offset voltage. The mathematical process for determining the sinusoidal waveform equivalent for any waveform is called *Fourier analysis*.
- Multiple-frequency voltage sources can be simulated for analysis by connecting several single-frequency voltage sources in series. Analysis of voltages and currents is accomplished by using the superposition theorem. NOTE: superimposed voltages and currents of different frequencies *cannot* be added together in complex number form, since complex numbers only account for amplitude and phase shift, not frequency!
- Harmonics can cause problems in power systems.